



CUTARO

CUTARO is the successful combination of natural wood with expressive craftsmanlike details and harmonious touches of colour. The new, fashionable light brown ash wood as well as the classical core walnut create a particularly warm and graceful appearance. The friendly colours of white and sand (with a high-gloss option) highlight these noble woods to particularly good effect. Specially selected leather enhancements allow the owner to create his own individual and highly attractive composition.

Wardrobes

Height reductions
at intervals of 1.0 cm
without surcharge

Hinge-door wardrobes according to the endless assembly principle

- for wood versions:
Outer hinge-doors of basic and end units with horizontal veneer, inner hinge-doors of basic and end units as well as extension units with vertical veneer; wardrobe doors with optional mirror (surcharge);
for lacquer/high-gloss versions:
all hinge-doors plain, with optional mirror (surcharge)
- Optionally - with all-round passepartout frame
 - with top LED lamp (12 V; 2.4 W)
 - with all-round passepartout frame and with top LED lamp (12 V; 2.4 W)
- Wardrobe interior carcass and wardrobe interior fittings in standard white lacquer version
- Standard interior fittings: 2 fitted shelves, 1 clothes rod
- Functional and high-quality **wardrobe interior fittings** (see separate chapter "Wardrobe interior fittings")

Beds



- Beds, optionally with bed surround in leather and with sideways protruding shaped headboard and two integrated consoles; consoles optionally with one or two drawers as well as 50 or 70 cm wide; in four widths and three lengths
- Bed surround in high-quality leather, optionally in white, sand or brown-black
- Comprehensive range of bed accessories: various bedside lamps, high-quality leather padding for headboard

In combination with the hülsta Sleeping System, the beds guarantee highest sleeping comfort. With its high-grade quality spring base frames and mattresses, the hülsta Sleeping System provides the perfect prerequisites for relaxing sleep (see separate chapter "**SLEEPING SYSTEMS**").

Ancillary units

- Consoles with two drawers; in two widths
- Chests in two heights and three widths; with four or five drawers or with two wooden doors; top drawer resp. right-hand wooden door with optional design fractal
- Angled shelves, optionally with lamp; in four widths
- Table lamp
- Mirrors

Quality features

- Wardrobe doors with solid wooden handle and high-quality spring hinges
- Lamps VDE tested
- Optically unobtrusive 2.5 mm drilled holes for wardrobes
- Centre partitions and end side-sections of wardrobes with special plinth adjustment
- **hülsta-SoftFlow**: Drawers of ancillary units on hidden bearings incl. auto pull-in feature with brake
- **hülsta-MagicClose**: All wooden hinge-doors with door hinge brake

Important notes: Generally speaking, you as a dealer/qualified fitter are responsible for the correct wall mounting of the units. That is why wall mounting should only be carried out by properly trained and qualified fitters. hülsta supplies materials for mounting units on walls for nearly all the units and which should be used for safety and for constructional reasons. The assembly materials supplied by hülsta (plugs, screws) are only suitable for fitting components on to concrete in firmness class (C12/15).

For other materials (please see separate materials table in the wall composition chapter) we provide you with an assembly mortar set as an extra order. Please note that this assembly mortar set is also only suitable for the materials listed in the materials table.

If walls are made up of other materials (e.g. plastered or lighter wall materials), one should use another method of mounting better suited to the load on site.

Please note that if the units are not mounted properly on the wall, there is a risk of the units falling down or tipping over – especially when alternative mounting materials acquired on site have been used.

For the reasons stated above it is absolutely essential to enquire about the composition of any walls before signing any contracts.

Lists of versions:

Wardrobes

Model no.	Wardrobe exterior carcasse	Model no.	Wardrobe front	Model no.	Wardrobe handle and passepartout	Model no.	Wardrobe interior carcasse and interior fittings
236 237	White lacquer Sand lacquer	236 237 238 239 240 241	White lacquer Sand lacquer High-gloss white High-gloss sand Light brown ash Core walnut	240 241	Light brown ash Core walnut	236	White lacquer

The model no. for the wardrobe exterior carcasse, wardrobe front, wardrobe handle and passepartout as well as for the wardrobe interior carcasse must be stated separately as colour combinations are possible.

Possible versions:

Handle version Hinge-door wardrobe

Handle 028

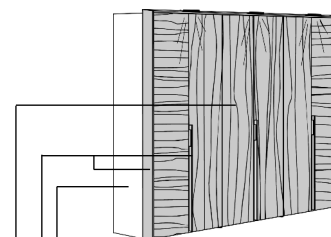
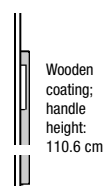

Wardrobe:

Wardrobe exterior carcasse in white lacquer or sand lacquer

Wardrobe handles and passepartout frame in light brown ash or core walnut

Wardrobe fronts in white lacquer, sand lacquer, high-gloss white, high-gloss sand, light brown ash or core walnut

Beds

Model no.	Bed headboard	Model no.	Bed surround * Console carcasse	Model no.	Console front
236 237 240 241	White lacquer Sand lacquer Light brown ash Core walnut	236 237	White lacquer Sand lacquer	236 237 238 239	White lacquer Sand lacquer Rear-lacquered glass, white Rear-lacquered glass, sand

The model no. for the bed headboard and bed surround as well as for the console carcasse and console front (for beds with side protruding shaped headboard) must be stated separately as colour combinations are possible.

* Bed surround also available in 3 different leather colours (white, sand or brown-black; against surcharge!)

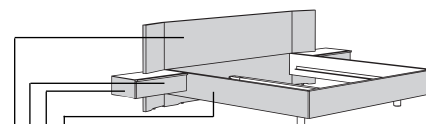

Bed:

Bed cramps always in the chosen wood version of console handles

Bed surround in white lacquer, sand lacquer or in 3 different leather colours, optionally in white, sand or brown-black

Console carcasse in white lacquer or sand lacquer

Console fronts in white lacquer, sand lacquer or rear-lacquered glass (white or sand)

Bed headboard in white lacquer, sand lacquer, light brown ash or core walnut

Ancillary units

Model no.	Ancillary unit carcasse	Model no.	Ancillary unit front	Model no.	Ancillary unit handle and design fractal
236 237	White lacquer Sand lacquer	236 237 238 239	White lacquer Sand lacquer Rear-lacquered glass, white Rear-lacquered glass, sand	240 241	Light brown ash Core walnut

The model no. for the ancillary unit carcasse, front, handle and design fractal must be stated separately as colour combinations are possible.

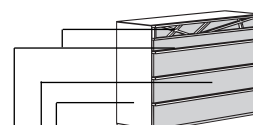

Ancillary units:

Ancillary unit carcasse in white lacquer or sand lacquer

Ancillary unit fronts in white lacquer, sand lacquer or rear-lacquered glass (white or sand)

Ancillary unit handles and design fractal in light brown ash or core walnut

Angled shelves and mirrors

Model no.	Version
240 241	Light brown ash Core walnut

Special combinations with beds with bed surround of wood

Please also note the mattresses and base frames in the separate chapter "SLEEPING SYSTEMS"!

Lists of versions: see page 5

Special combinations consisting of a bed unit (bed with bed surround of wood and two (integrated) drawer consoles) and a hinge-door wardrobe.

The price of an entire special combination (bed unit and wardrobe) can be found in the grey shaded boxes!

Bed unit with bed surround of wood:

consisting of a standard bed with bed surround of wood and two drawer consoles, optionally 50 or 70 cm wide, or of a bed with a shaped headboard protruding sideways left and right and two integrated consoles, optionally with 1 or 2 drawers and optionally 50 cm or 70 cm wide.

Hinge-door wardrobe:

for wood versions: outer hinge-doors with horizontal veneer, centre hinge-doors with vertical veneer; for lacquer/high-gloss versions: wardrobe doors plain; Hinge-doors, with optional mirror (surcharge), with solid wooden handle. Height reductions of wardrobes at intervals of 1.0 cm without surcharge.

Please state all surface versions clearly in the order (see here the information on surface versions on page 5)!

Special-sized products for special combinations are possible immediately! **Pricing:** recommended retail price of the special combination + 15% plus the recommended retail prices of all the required special-sized products (see here the chapter on "Special-sized products")!

Please note: Height reductions of wardrobes remain free of charge!

ADVANTAGE!

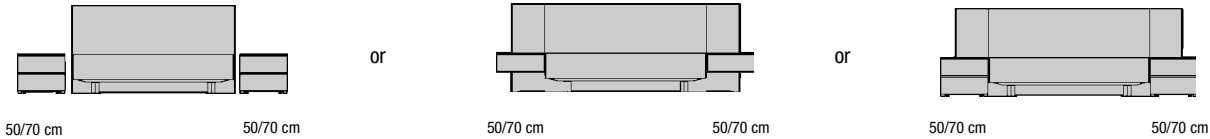

Important: Choose a bed (all bed sizes possible – please state type number; see page 12-14), two consoles (only for the standard bed; all types of console possible – please state type number; see page 16) as well as one of the wardrobes listed below.

4-door hinge-door wardrobe 202 cm wide	5-door hinge-door wardrobe (middle door with hinges right) 252 cm wide			6-door hinge-door wardrobe 302 cm wide					
	Information on the energy class: see page 8 below!			Information on the energy class: see page 8 below!					
		Surcharge for passe-partout	Surcharge for top LED lamp 1 lamp per unit		Surcharge for passe-partout	Surcharge for top LED lamp 1 lamp per unit		Surcharge for passe-partout	Surcharge for top LED lamp 1 lamp per unit
A 8406		301	0383	A 8416	303	0385	A 8436	304	0385

Additional fittings Please see also the information on page 8!

Remote control unit Surcharge for remote control unit (transmitter + receiver) type 1601 = Surcharge for extra transmitter type 1602 = Surcharge for extra receiver type 1603 =	Top LED lamp Surcharge for each additional lamp type 3690 = This luminaire contains built-in LED lamps of the energy classes A++ to A. The lamps cannot be changed in the luminaire. 12 V; 2.4 W	Surcharge for mirror Each wardrobe door can be optionally fitted with a mirror (vertical facette) for which a surcharge is made. Mirror surcharge per hinge-door:
---	---	---

Special combinations with beds with bed surround of leather

Please also note the mattresses and base frames in the separate chapter "SLEEPING SYSTEMS"!

Special combinations consisting of a bed unit (bed with bed surround in high-quality leather, optionally in white, sand or brown-black, and two (integrated) drawer consoles) and a hinge-door wardrobe.

The price of an entire special combination (bed unit and wardrobe) can be found in the grey shaded boxes!

Bed unit with bed surround in high-quality leather:

consisting of a standard bed with bed surround in high-quality leather, optionally in white, sand or brown-black, and two drawer consoles, optionally 50 or 70 cm wide, or of a bed with a shaped headboard protruding sideways left and right and two integrated consoles, optionally with 1 or 2 drawers and optionally 50 cm or 70 cm wide.

Hinge-door wardrobe:

for wood versions: outer hinge-doors with horizontal veneer, centre hinge-doors with vertical veneer;
for lacquer/high-gloss versions: wardrobe doors plain;
Hinge-doors, with optional mirror (surcharge), with solid wooden handle.
Height reductions of wardrobes at intervals of 1.0 cm without surcharge.

Please state all surface versions clearly in the order (see here the information on surface versions on page 5)!

Special-sized products for special combinations are possible immediately! **Pricing:** recommended retail price of the special combination + 15% plus the recommended retail prices of all the required special-sized products (see here the chapter on "Special-sized products")!
Please note: Height reductions of wardrobes remain free of charge!

ADVANTAGE!

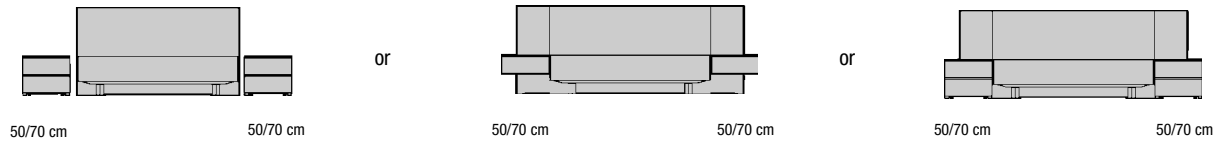

Important: Choose a bed (all bed sizes possible – please state type number; see page 12-14), two consoles (only for the standard bed; all types of console possible – please state type number; see page 16) as well as one of the wardrobes listed below. Please be sure to state the **leather colour of the bed surround** in your order (optionally in white, sand or brown-black)!

	4-door hinge-door wardrobe		5-door hinge-door wardrobe (middle door with hinges right)		6-door hinge-door wardrobe	
	202 cm wide		252 cm wide		302 cm wide	
	Information on the energy class: see page 8 below!		Information on the energy class: see page 8 below!		Information on the energy class: see page 8 below!	
		Surcharge for passe-partout	Surcharge for top LED lamp		Surcharge for top LED lamp	
			1 lamp per unit		1 lamp per unit	
	A 84061	301	0383	A 84161	303	0385
					A 84361	304
						0385

Additional fittings Please see also the information on page 8!

<p>Remote control unit</p> <p>Surcharge for remote control unit (transmitter + receiver) type 1601 =</p> <p>Surcharge for extra transmitter type 1602 =</p> <p>Surcharge for extra receiver type 1603 =</p>	<p>Top LED lamp</p> <p>Surcharge for each additional lamp type 3690 =</p> <p>This luminaire contains built-in LED lamps of the energy classes A++ to A. The lamps cannot be changed in the luminaire. 12 V; 2.4 W</p>	<p>Surcharge for mirror</p> <p>Each wardrobe door can be optionally fitted with a mirror (vertical facette) for which a surcharge is made.</p> <p>Mirror surcharge per hinge-door:</p>
--	--	--

Notes on planning hinge-door wardrobes according to the endless assembly principle

consisting of basic, extension and end units. Due to the various element widths one can create many total wardrobe widths. In this way the available floor space can be exploited to the full. For each wardrobe combination, the first element on the left is considered to be the basic unit, incorporating both outer side-sections. One can only include one basic unit in each combination. When adding on extension units, the right-hand side-section of the basic unit is employed as the end side-section of the complete combination. In the case of single-door hinge-door units one can choose between left- and right-hand hinges. The graphics shown below give you an excerpt of our wardrobe assortment.

Standard interior fittings per unit: 2 fitted shelves, 1 clothes rod.
All interior surfaces are in white lacquer.

Dims.

	without passepartout	with passepartout	without passepartout, with top LED lamp	with passepartout and top LED lamp
Heights incl. plinth	229.6 cm	233.1 cm	233.6 cm	235.6 cm
Height reductions at intervals of 1.0 cm without surcharge				
Depths	61.0 cm	63.0 cm	72.0 cm	70.7 cm
Widths	see pages 9-11			

Examples of wardrobes

Hinge-door wardrobe

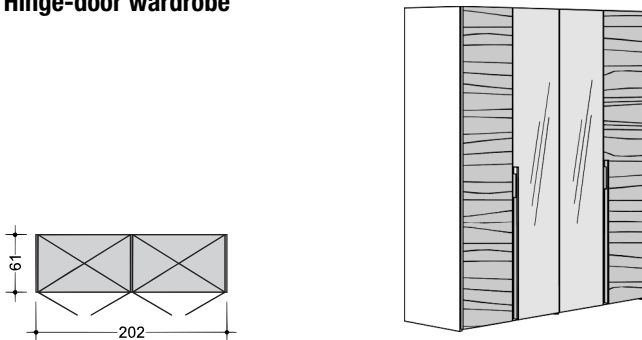

- Hinge-door wardrobes consisting of basic, extension and end units
- for wood versions:
Basic unit: left door with horizontal veneer, right door with vertical veneer;
Extension and end unit: doors of extension units and left door of end units with vertical veneer, right door of end units with horizontal veneer;
for lacquer/high-gloss versions: all hinge-doors plain
- Front mirrors at a surcharge
- Unit outside widths: 42, 52, 82, 102 cm (basic units)
40, 50, 80, 100 cm (extension and end units)
- Unit inside widths: 38, 48, 78, 98 cm
- Outside depth: 61 cm
- Inside depth: 56 cm
- Door opening angle: approx. 94°

For calculating the total width when fitting the passepartout frame, please note the passepartout frame protrusion of 2.4 cm left and right!

Hinge-door wardrobe

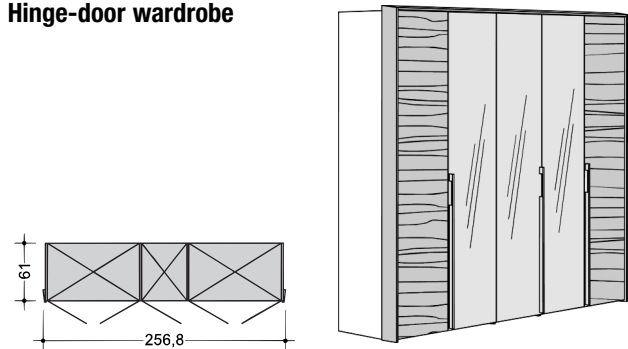

- Hinge-door wardrobes consisting of basic, extension and end units
- for wood versions:
Basic unit: left door with horizontal veneer, right door with vertical veneer;
Extension and end unit: doors of extension units and left door of end units with vertical veneer, right door of end units with horizontal veneer;
for lacquer/high-gloss versions: all hinge-doors plain
- Front mirrors at a surcharge
- Unit outside widths: 42, 52, 82, 102 cm (basic units)
40, 50, 80, 100 cm (extension and end units)
- Unit inside widths: 38, 48, 78, 98 cm
- Outside depth: 61 cm
- Inside depth: 56 cm
- Door opening angle: approx. 94°

For calculating the total width when fitting the passepartout frame, please note the passepartout frame protrusion of 2.4 cm left and right!

Hinge-door wardrobe

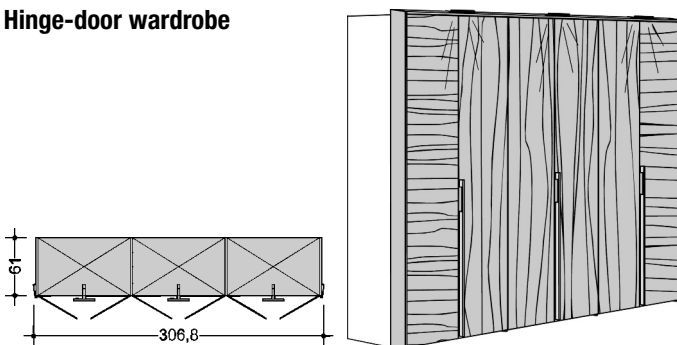

- Hinge-door wardrobes consisting of basic, extension and end units
- for wood versions:
Basic unit: left door with horizontal veneer, right door with vertical veneer;
Extension and end unit: doors of extension units and left door of end units with vertical veneer, right door of end units with horizontal veneer;
for lacquer/high-gloss versions: all hinge-doors plain
- Front mirrors at a surcharge
- Unit outside widths: 42, 52, 82, 102 cm (basic units)
40, 50, 80, 100 cm (extension and end units)
- Unit inside widths: 38, 48, 78, 98 cm
- Outside depth: 61 cm
- Inside depth: 56 cm
- Door opening angle: approx. 94°

For calculating the total width when fitting the passepartout frame, please note the passepartout frame protrusion of 2.4 cm left and right!

Lamps

All hinge-door wardrobes are available with a top LED lamp. The top LED lamp is fitted standard above each element – 1 or 2 door – 12 V; 2.4 W.

If required, a top LED lamp can be fitted centrally above each door. Please include a sketch in all cases.

Switching is done by an external footswitch. A remote control unit is also available as an alternative, which is charged extra. The remote control unit incorporates one transmitter and one receiver which operate all the LED lamps. Extra transmitters are available against a surcharge. The footswitch is omitted when the remote control unit is employed.

Please note: When planning the passepartout, please note that a minimum distance of 2.0 cm to the ceiling must be observed.

Remote control unit

Surcharge for remote control unit (transmitter + receiver) type	1601 =	
Surcharge for extra transmitter type	1602 =	
Surcharge for extra receiver type	1603 =	

Top LED lamp



Surcharge for each additional lamp type	3690 =	
--	---------------	---

This luminaire contains built-in LED lamps of the energy classes A++ to A. The lamps cannot be changed in the luminaire. 12 V; 2.4 W

For each project please remember to leave a 2.0 cm gap to the ceiling and at the side for assembly!

Hinge-door wardrobes - Basic units

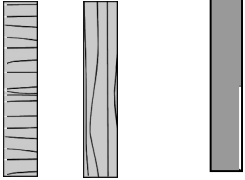
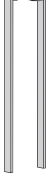
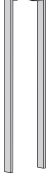
CUTARO

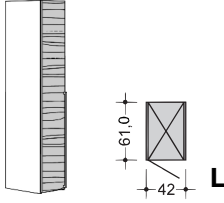
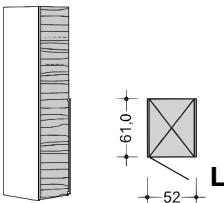
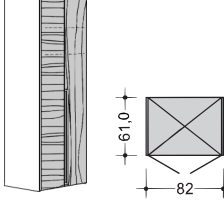
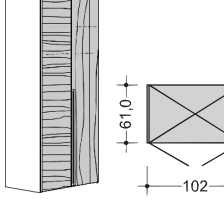
<p>Height: 229.6 cm (Height with passepartout and/or top LED lamp: see table page 8 top right; height reductions at intervals of 1.0 cm without surcharge)</p> <p>Width: see table (with passepartout + 2.4 cm each side)</p> <p>Depth: 61.0 cm (Depth with passepartout and/or top LED lamp: see table page 8 top right)</p> <p>Standard interior fittings per unit: 2 fitted shelves, 1 clothes rod; All interior surfaces are in a standard white lacquer version. Hinge-doors, with optional mirror (surcharge), with a solid wooden handle. The surcharge for the passepartout frame of the basic units includes the left- and right-hand vertical frame as well as the horizontal frame, the surcharge for the extension units only includes the horizontal frame. When adding on extension units, the right-hand frame of the passepartout of the basic unit is employed as the end unit of the complete combination. The passepartout is supplied in a standard wooden coated version. The passepartout unit is full-length up to 302 cm width.</p>	<p>for wood versions: (left) wardrobe door with horizontal veneer, (right) wardrobe door with vertical veneer</p> 	<p>for lacquer/high-gloss versions: wardrobe doors plain</p> 	<p>Surcharge for passepartout</p> 	<p>Surcharge for top LED lamp 1 lamp per unit</p>  <p>Information on the energy class: see page 8 below!</p>	<p>Surcharge for mirror</p> <p>Each wardrobe door can be optionally fitted with a mirror (vertical facette) for which a surcharge is made.</p> 
<p>Basic units with 2 outer side-sections (each 2 cm thick) For each wardrobe combination, the first element on the left is considered to be the basic unit, incorporating both outer side-sections. One can only include one basic unit in each combination. When adding on extension units, the right-hand side-section of the basic unit is employed as the end side-section of the complete combination.</p> <p>Please also note the functional and high-quality wardrobe interior fittings as well as the special articles and possible special-sized products in the separate chapters on "Wardrobe interior fittings" and "Special products".</p>					
 <p>Basic unit single door, left or right, 42 cm wide</p> <p>for wood versions: door with horizontal veneer</p> <p>for lacquer/high-gloss versions: door plain</p>	<p>A 02011 L A 02012 R</p>	<p>341</p>	<p>380</p>	<p>Please mark exactly in the front sketch or state in the order (from the left) which hinge-doors are to be fitted with a mirror.</p> <p>Mirror surcharge per hinge-door:</p>	
 <p>Basic unit single door, left or right, 52 cm wide</p> <p>for wood versions: door with horizontal veneer</p> <p>for lacquer/high-gloss versions: door plain</p>	<p>A 2011 L A 2012 R</p>	<p>342</p>	<p>380</p>		
 <p>Basic unit twin door, 82 cm wide</p> <p>for wood versions: left door with horizontal veneer, right door with vertical veneer</p> <p>for lacquer/high-gloss versions: doors plain</p>	<p>A 0202</p>	<p>343</p>	<p>380</p>	<p>Please mark exactly in the front sketch or state in the order (from the left) which hinge-doors are to be fitted with a mirror.</p> <p>Mirror surcharge per hinge-door:</p>	
 <p>Basic unit twin door, 102 cm wide</p> <p>for wood versions: left door with horizontal veneer, right door with vertical veneer</p> <p>for lacquer/high-gloss versions: doors plain</p>	<p>A 202</p>	<p>344</p>	<p>380</p>		









Additional fittings for lamps Please see also the information on page 8!

<p>Remote control unit</p> <p>Surcharge for remote control unit (transmitter + receiver) type 1601 =</p> <p>Surcharge for extra transmitter type 1602 =</p> <p>Surcharge for extra receiver type 1603 =</p>	<p>Top LED lamp</p> <p>Surcharge for each additional lamp type 3690 =</p> <p>This luminaire contains built-in LED lamps of the energy classes A++ to A. The lamps cannot be changed in the luminaire. 12 V; 2.4 W</p> 
--	--

Hinge-door wardrobes - Extension units

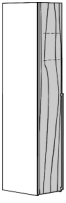
For each project please remember to leave a 2.0 cm gap to the ceiling and at the side for assembly!

Lists of versions: see page 5

<p>Height: 229.6 cm (Height with passepartout and/or top LED lamp: see table page 8 top right; height reductions at intervals of 1.0 cm without surcharge) Width: see table (with passepartout + 2.4 cm each side) Depth: 61.0 cm (Depth with passepartout and/or top LED lamp: see table page 8 top right)</p> <p>Standard interior fittings per unit: 2 fitted shelves, 1 clothes rod; All interior surfaces are in a standard white lacquer version. Hinge-doors, with optional mirror (surcharge), with a solid wooden handle. The surcharge for the passepartout frame of the extension units only includes the horizontal frame. When adding on extension and end units, the right-hand frame of the passepartout of the basic unit is used as the end unit of the complete combination. The passepartout is supplied in a standard wooden coated version. The passepartout unit is full-length up to 302 cm width.</p>	<p>for wood versions: wardrobe doors with vertical veneer</p> 	<p>for lacquer/high-gloss versions: wardrobe doors plain</p> 	<p>Surcharge for passepartout</p> 	<p>Surcharge for top LED lamp 1 lamp per unit</p>  <p>Information on the energy class: see page 8 below!</p>	<p>Surcharge for mirror</p> <p>Each wardrobe door can be optionally fitted with a mirror (vertical facette) for which a surcharge is made.</p> 
<p>Extension units with 1 centre partition (2 cm thick)</p>		<p>Please also note the functional and high-quality wardrobe interior fittings as well as the special articles and possible special-sized products in the separate chapters on "Wardrobe interior fittings" and "Special products".</p>			
 <p>Extension unit single door, left or right, 40 cm wide</p> <p>for wood versions: door with vertical veneer for lacquer/high-gloss versions: door plain</p>	<p>A 00011 L A 00012 R</p>	<p>346</p>	<p>382</p>		
 <p>Extension unit single door, left or right, 50 cm wide</p> <p>for wood versions: door with vertical veneer for lacquer/high-gloss versions: door plain</p>	<p>A 0011 L A 0012 R</p>	<p>347</p>	<p>382</p>		<p>Please mark exactly in the front sketch or state in the order (from the left) which hinge-doors are to be fitted with a mirror.</p>
 <p>Extension unit twin door, 80 cm wide</p> <p>for wood versions: doors with vertical veneer for lacquer/high-gloss versions: doors plain</p>	<p>A 0002</p>	<p>348</p>	<p>382</p>		<p>Mirror surcharge per hinge-door:</p>
 <p>Extension unit twin door, 100 cm wide</p> <p>for wood versions: doors with vertical veneer for lacquer/high-gloss versions: doors plain</p>	<p>A 002</p>	<p>349</p>	<p>382</p>		





Additional fittings for lamps Please see also the information on page 8!

<p>Remote control unit</p> <p>Surcharge for remote control unit (transmitter + receiver) type 1601 = Surcharge for extra transmitter type 1602 = Surcharge for extra receiver type 1603 =</p>	<p>Top LED lamp</p>  <p>Surcharge for each additional lamp type 3690 = This luminaire contains built-in LED lamps of the energy classes A++ to A. The lamps cannot be changed in the luminaire. 12 V; 2.4 W</p>
---	--

Hinge-door wardrobes - End units

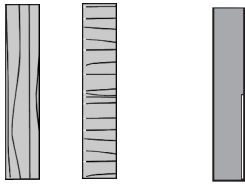
For each project please remember to leave a 2.0 cm gap to the ceiling and at the side for assembly!

CUTARO

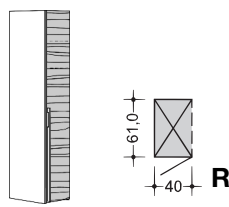
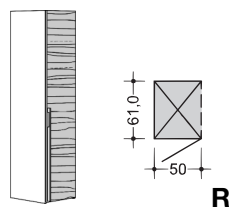
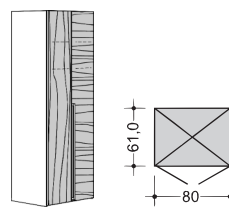
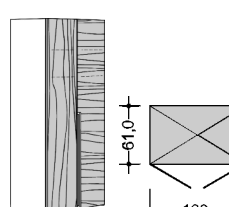
<p>Height: 229.6 cm (Height with passepartout and/or top LED lamp: see table page 8 top right; height reductions at intervals of 1.0 cm without surcharge)</p> <p>Width: see table (with passepartout + 2.4 cm each side)</p> <p>Depth: 61.0 cm (Depth with passepartout and/or top LED lamp: see table page 8 top right)</p> <p>Standard interior fittings per unit: 2 fitted shelves, 1 clothes rod; All interior surfaces are in a standard white lacquer version. Hinge-doors, with optional mirror (surcharge), with a solid wooden handle. The surcharge for the passepartout frame of the end units only includes the horizontal frame. When adding on extension and end units, the right-hand frame of the passepartout of the basic unit is used as the end unit of the complete combination. The passepartout is supplied in a standard wooden coated version. The passepartout unit is full-length up to 302 cm width.</p>	<p>for wood versions: (left) wardrobe door with vertical veneer, (right) wardrobe door with horizontal veneer</p> 	<p>for lacquer/high-gloss versions: wardrobe doors plain</p> 	<p>Surcharge for passepartout</p> 	<p>Surcharge for top LED lamp 1 lamp per unit</p>  <p>Information on the energy class: see page 8 below!</p>	<p>Surcharge for mirror</p> <p>Each wardrobe door can be optionally fitted with a mirror (vertical facette) for which a surcharge is made.</p> 
<p>End units with 1 centre partition (2 cm thick)</p>		<p>Please also note the functional and high-quality wardrobe interior fittings as well as the special articles and possible special-sized products in the separate chapters on "Wardrobe interior fittings" and "Special products".</p>			
 <p>End unit single door, left or right, 40 cm wide</p> <p>for wood versions: door with horizontal veneer</p> <p>for lacquer/high-gloss versions: door plain</p>	<p>A 0021 L A 0022 R</p>	<p>346</p>	<p>382</p>	<p>Please mark exactly in the front sketch or state in the order (from the left) which hinge-doors are to be fitted with a mirror.</p> <p>Mirror surcharge per hinge-door:</p>	
 <p>End unit single door, left or right, 50 cm wide</p> <p>for wood versions: door with horizontal veneer</p> <p>for lacquer/high-gloss versions: door plain</p>	<p>A 0021 L A 0022 R</p>	<p>347</p>	<p>382</p>		
 <p>End unit twin door, 80 cm wide</p> <p>for wood versions: left door with vertical veneer, right door with horizontal veneer</p> <p>for lacquer/high-gloss versions: doors plain</p>	<p>A 012</p>	<p>348</p>	<p>382</p>		
 <p>End unit twin door, 100 cm wide</p> <p>for wood versions: left door with vertical veneer, right door with horizontal veneer</p> <p>for lacquer/high-gloss versions: doors plain</p>	<p>A 022</p>	<p>349</p>	<p>382</p>		

Additional fittings for lamps Please see also the information on page 8!

<p>Remote control unit</p> <p>Surcharge for remote control unit (transmitter + receiver) type 1601 =</p> <p>Surcharge for extra transmitter type 1602 =</p> <p>Surcharge for extra receiver type 1603 =</p>	<p>Top LED lamp</p> <p>Surcharge for each additional lamp type 3690 =</p> <p>This luminaire contains built-in LED lamps of the energy classes A++ to A. The lamps cannot be changed in the luminaire. 12 V; 2.4 W</p> 
--	--

Beds

Please also note the mattresses and base frames in the separate chapter "SLEEPING SYSTEMS"!

Lists of versions: see page 5

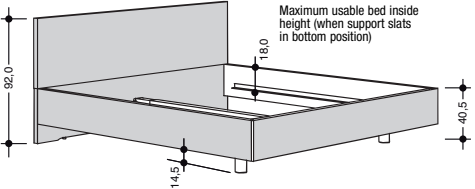



Bed Beds incl. support slats for base frames and mattresses • Adjustable in height by 3.2 cm downwards and upwards • Usable bed inside height (see here the information in the "Special-sized products" chapter): max. 18.0 cm Bed surround in leather: The bed surround can also be ordered in high-quality leather (100% Nappa leather, pigmented; optionally in white, sand or brown-black). Surcharge: Please state all surface versions clearly in the order (see here the information on surface versions on page 5)! 	Inside dims.	Outside dims.	Type no.	
	140x200 160x200 180x200 200x200	151.3x211.3 171.3x211.3 191.3x211.3 211.3x211.3	825 826 827 828	
	140x210 160x210 180x210 200x210	151.3x221.3 171.3x221.3 191.3x221.3 211.3x221.3	835 836 837 838	
	140x220 160x220 180x220 200x220	151.3x231.3 171.3x231.3 191.3x231.3 211.3x231.3	845 846 847 848	

Beds with side protruding shaped headboard and 50 cm wide consoles

Bed accessories:
see page 15!

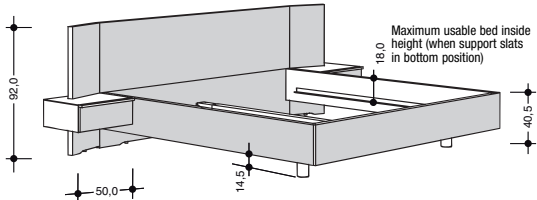
CUTARO

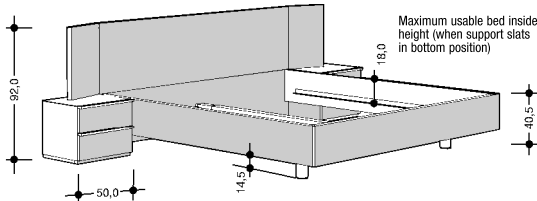

Please also note the mattresses and base frames in the separate chapter "SLEEPING SYSTEMS"!

Bed with shaped headboard protruding at left and right sides and two integrated, 50 cm wide consoles with 1 drawer Beds incl. support slats for base frames and mattresses • Adjustable in height by 3.2 cm downwards and upwards • Usable bed inside height (see here the information in the "Special-sized products" chapter): max. 18.0 cm Bed surround in leather: The bed surround can also be ordered in high-quality leather (100% Nappa leather, pigmented; optionally in white, sand or brown-black). Surcharge: Please state all surface versions clearly in the order (see here the information on surface versions on page 5)! 	Inside dims.	Outside dims.	Type no.	
	140x200 160x200 180x200 200x200	250.3x211.3 270.3x211.3 290.3x211.3 310.3x211.3	82551 82651 82751 82851	
	140x210 160x210 180x210 200x210	250.3x221.3 270.3x221.3 290.3x221.3 310.3x221.3	83551 83651 83751 83851	
Note: Max. load of consoles: 10 kg	140x220 160x220 180x220 200x220	250.3x231.3 270.3x231.3 290.3x231.3 310.3x231.3	84551 84651 84751 84851	
Bed with shaped headboard protruding at left and right sides and two integrated, 50 cm wide consoles with 2 drawers Beds incl. support slats for base frames and mattresses • Adjustable in height by 3.2 cm downwards and upwards • Usable bed inside height (see here the information in the "Special-sized products" chapter): max. 18.0 cm Bed surround in leather: The bed surround can also be ordered in high-quality leather (100% Nappa leather, pigmented; optionally in white, sand or brown-black). Surcharge: Please state all surface versions clearly in the order (see here the information on surface versions on page 5)! 		140x200 160x200 180x200 200x200	250.3x211.3 270.3x211.3 290.3x211.3 310.3x211.3	82552 82652 82752 82852
	140x210 160x210 180x210 200x210	250.3x221.3 270.3x221.3 290.3x221.3 310.3x221.3	83552 83652 83752 83852	
	140x220 160x220 180x220 200x220	250.3x231.3 270.3x231.3 290.3x231.3 310.3x231.3	84552 84652 84752 84852	

Beds with side protruding shaped headboard and 70 cm wide consoles

Please also note the mattresses and base frames in the separate chapter "SLEEPING SYSTEMS"!

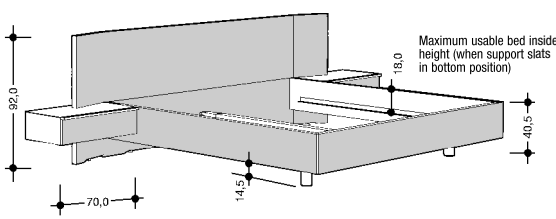
Lists of versions: see page 5

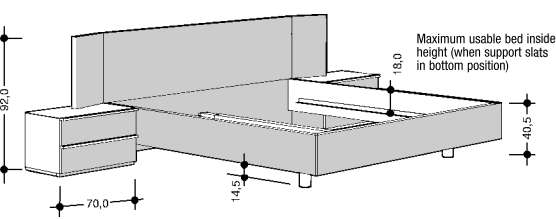
Bed with shaped headboard protruding at left and right sides and two integrated, 70 cm wide consoles with 1 drawer Beds incl. support slats for base frames and mattresses • Adjustable in height by 3.2 cm downwards and upwards • Usable bed inside height (see here the information in the "Special-sized products" chapter): max. 18.0 cm Bed surround in leather: The bed surround can also be ordered in high-quality leather (100% Nappa leather, pigmented; optionally in white, sand or brown-black). Surcharge: 	Inside dims.	Outside dims.	Type no.	
<p>Please state all surface versions clearly in the order (see here the information on surface versions on page 5)!</p> 	140x200 160x200 180x200 200x200	290.3x211.3 310.3x211.3 330.3x211.3 350.3x211.3	82571 82671 82771 82871	
	140x210 160x210 180x210 200x210	290.3x221.3 310.3x221.3 330.3x221.3 350.3x221.3	83571 83671 83771 83871	
<p>Note: Max. load of consoles: 10 kg</p>	140x220 160x220 180x220 200x220	290.3x231.3 310.3x231.3 330.3x231.3 350.3x231.3	84571 84671 84771 84871	
Bed with shaped headboard protruding at left and right sides and two integrated, 70 cm wide consoles with 2 drawers Beds incl. support slats for base frames and mattresses • Adjustable in height by 3.2 cm downwards and upwards • Usable bed inside height (see here the information in the "Special-sized products" chapter): max. 18.0 cm Bed surround in leather: The bed surround can also be ordered in high-quality leather (100% Nappa leather, pigmented; optionally in white, sand or brown-black). Surcharge: 	140x200 160x200 180x200 200x200	290.3x211.3 310.3x211.3 330.3x211.3 350.3x211.3	82572 82672 82772 82872	
<p>Please state all surface versions clearly in the order (see here the information on surface versions on page 5)!</p> 	140x210 160x210 180x210 200x210	290.3x221.3 310.3x221.3 330.3x221.3 350.3x221.3	83572 83672 83772 83872	
	140x220 160x220 180x220 200x220	290.3x231.3 310.3x231.3 330.3x231.3 350.3x231.3	84572 84672 84772 84872	

High-quality leather padding A for headboard

100% Nappa leather, pigmented
42.0 cm high, approx. 3.0 cm thick;
optionally in white, sand or brown-black;
hangs over headboard; this increases the total
height of the bed by approx. 3 cm

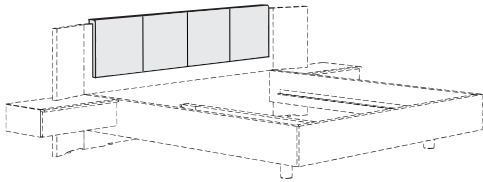

for bed width	padding width	Leather padding A		
		white	sand	brown-black
140 cm	130 cm	6011	6012	6013
160 cm	150 cm	6021	6022	6023
180 cm	170 cm	6031	6032	6033
200 cm	190 cm	6041	6042	6043

High-quality leather padding B for headboard

100% Nappa leather, pigmented
42.0 cm high, approx. 3.0 cm thick;
optionally in white, sand or brown-black;
hangs over headboard; this increases the total
height of the bed by approx. 3 cm

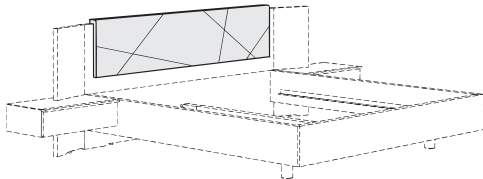

for bed width	padding width	Leather padding B		
		white	sand	brown-black
140 cm	130 cm	8011	8012	8013
160 cm	150 cm	8021	8022	8023
180 cm	170 cm	8031	8032	8033
200 cm	190 cm	8041	8042	8043

Swing-out LED bedside reading lamps with swan-neck

Set of 2; chrome;
for fitting in headboard (left and right); later fitting not possible.

This luminaire contains built-in LED lamps of the energy classes A++ to A.
The lamps cannot be changed in the luminaire. 12 V; 2.5 W

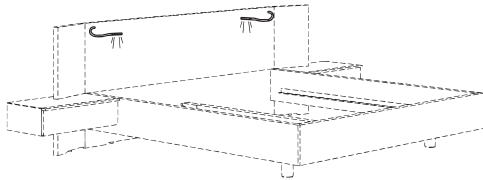

978 Set of 2

LED lamp for sideways protruding shaped headboard

Set of 2;
for fitting behind the shaped headboard protruding left and right; later fitting not possible.

This luminaire is compatible with lamps of the energy classes A++ to B.
This luminaire is sold with a lamp of the energy class A+. 12 V; 7 W

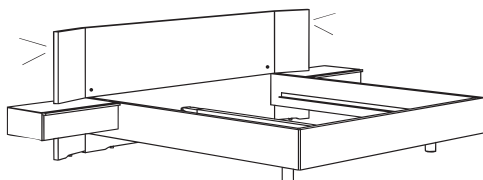

980 Set of 2

LED bedside lamp (pair)

with motion sensor for switching on and off (no time interval)

This luminaire contains built-in LED lamps of the energy classes A++ to A.
The lamps cannot be changed in the luminaire. 12 V; 1.8 W

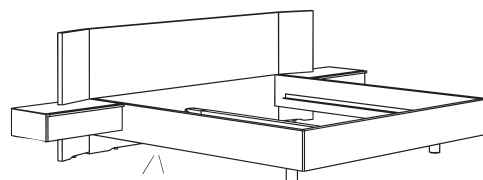







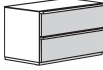

894

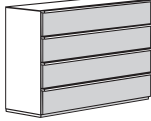
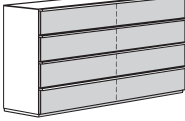
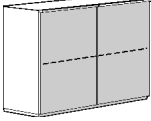
Ancillary units

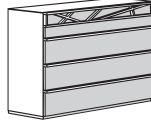
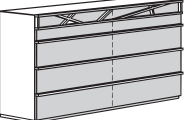
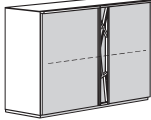

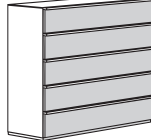
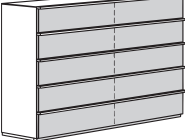
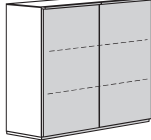

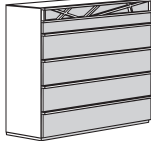
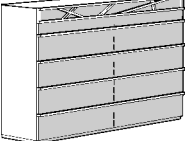
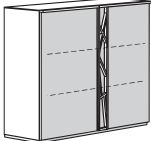
Please state all surface versions clearly in the order
(see here the information on surface versions on page 5!)

Lists of versions: see page 5





<p>Consoles 40.5 cm high 42.0 cm deep</p> <p>For beds without sideways protruding shaped headboard Cover shelves of rear-lacquered glass, white or sand Max. load of cover shelf: 20 kg</p> <p>LED inside drawer lamps</p>	<p>2 drawers</p> <div style="display: flex; justify-content: space-around; align-items: center;"> <div style="text-align: center;">  50 cm wide </div> <div style="text-align: center;">  70 cm wide </div> </div>			<p>LED inside drawer lamps Consoles with drawers can be fitted with optional LED inside drawer lamps (7.5 V, 1.0 W powered by standard AAA 1.5 V batteries included - rechargeable batteries not possible; with automatic on/off switch).</p> <p>Please state exactly in your order which drawer is to be fitted with LED inside drawer lamps.</p> <p>Surcharge for LED inside drawer lamps per drawer: This type of luminaire is excepted from obligatory labelling in accordance with EU-VO 874/2012 guidelines (Reason: battery-operated and/or <30 Lumen).</p>
<p>Chests 79.0 cm high 42.0 cm deep</p> <p>Cover shelves of rear-lacquered glass, white or sand Max. load of cover shelf: 20 kg</p>	<p>4 drawers (with split drawer frames for 160 cm width)</p> <div style="display: flex; justify-content: space-around; align-items: center;"> <div style="text-align: center;">  70 cm wide </div> <div style="text-align: center;">  120 cm wide </div> <div style="text-align: center;">  160 cm wide </div> </div>			<p>2 wooden doors with 1 fitted wooden shelf</p> <p>Sideward distance must be 2 cm (per door) to open doors fully.</p> <div style="text-align: center;">  120 cm wide </div>
<p>Chests 79.0 cm high 42.0 cm deep</p> <p>Cover shelves of rear-lacquered glass, white or sand Top drawer or right door with design fractal; design fractal in light brown ash or in core walnut Max. load of cover shelf: 20 kg</p>	<p>4 drawers (with split drawer frames for 160 cm width)</p> <div style="display: flex; justify-content: space-around; align-items: center;"> <div style="text-align: center;">  70 cm wide </div> <div style="text-align: center;">  120 cm wide </div> <div style="text-align: center;">  160 cm wide </div> </div>			<p>2 wooden doors with 1 fitted wooden shelf</p> <p>Sideward distance must be 2 cm (per door) to open doors fully.</p> <div style="text-align: center;">  120 cm wide </div>
<p>Chests 98.1 cm high 42.0 cm deep</p> <p>Cover shelves of rear-lacquered glass, white or sand Max. load of cover shelf: 20 kg</p>	<p>5 drawers (with split drawer frames for 160 cm width)</p> <div style="display: flex; justify-content: space-around; align-items: center;"> <div style="text-align: center;">  70 cm wide </div> <div style="text-align: center;">  120 cm wide </div> <div style="text-align: center;">  160 cm wide </div> </div>			<p>2 wooden doors with 2 fitted wooden shelves</p> <p>Sideward distance must be 2 cm (per door) to open doors fully.</p> <div style="text-align: center;">  120 cm wide </div>
<p>Chests 98.1 cm high 42.0 cm deep</p> <p>Cover shelves of rear-lacquered glass, white or sand Top drawer or right door with design fractal; design fractal in light brown ash or in core walnut Max. load of cover shelf: 20 kg</p>	<p>5 drawers (with split drawer frames for 160 cm width)</p> <div style="display: flex; justify-content: space-around; align-items: center;"> <div style="text-align: center;">  70 cm wide </div> <div style="text-align: center;">  120 cm wide </div> <div style="text-align: center;">  160 cm wide </div> </div>			<p>2 wooden doors with 2 fitted wooden shelves</p> <p>Sideward distance must be 2 cm (per door) to open doors fully.</p> <div style="text-align: center;">  120 cm wide </div>

Angled shelves with shelf of glass

CUTARO

<p>Angled shelves 19.2 cm high 19.7 cm deep for fitting anywhere on wall; invisible, adjustable special bracket Rear wall panel of wood, shelf of glass Max. load: 15 kg</p>	Angled shelf			
	 50 cm wide	 70 cm wide	 120 cm wide	 160 cm wide
	5050	5070	5120	5160

Angled shelves with shelf of glass and lamp

<p>Angled shelves with lamp 19.2 cm high 19.7 cm deep for fitting anywhere on wall; invisible, adjustable special bracket Rear wall panel of wood, shelf of glass with LED lamps, incl. foot- switch; remote control unit (see page 8) or Magic-Tronic (see below) possible against surcharge Max. load: 15 kg</p>	Angled shelf with lamp			
	<div style="border: 1px solid gray; padding: 5px; margin: 10px auto; width: 80%;"> This luminaire contains built-in LED lamps of the energy classes A++ to A. The lamps cannot be changed in the luminaire. 12 V; 1 W per lamp </div>			
	 50 cm wide	 70 cm wide	 120 cm wide	 160 cm wide
	5051	5071	5121	5161

Magic-Tronic

The lamps are normally operated by an external footswitch. As an alternative we can also provide a **Magic-Tronic** switch, which is charged extra. By "stroking" the outer or top side of the unit at the same level as the invisible integrated sensor it is possible to switch all the lamps on and off ("Stroking method"). As an alternative the position of the hidden sensor can also be marked with a small metal plate on the furniture unit ("Marking method"). Lamps with a maximum power of 200 W can be operated by a Magic-Tronic unit (230 V). The footswitch is omitted when a Magic-Tronic unit is included.

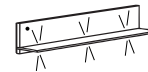

Please be sure to observe the information and notes regarding the assembly position given in the chapter "Switch options for lamps"!



7617

Table lamp

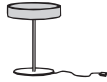
This luminaire is compatible with lamps of the energy classes A to E.
This luminaire is sold with a lamp of the energy class A. 230 V; 2x 7 W

<p>Table lamp 41.0 cm high Lampshade cover black or white silk gloss outside, chrome colour inside; with pull switch.</p>	Table lamp black	Table lamp white
	 Ø 30,0 cm	 Ø 30,0 cm
	562	561

Mirrors

<p>Mirrors Depth: 4.0 cm with all-round frame, 1.4 cm thick with design fractal look and satinized decorative stripe on one (narrow) side can be fitted horizontally and vertically</p>	<p>Mirror</p>  70 x 120 cm
	527



Wardrobe interior fittings

With these high-quality interior fittings for wardrobes hülsta has developed a system that meets every individual furnishing needs. The great number of different unit types, a wide spectrum of sizes, as well as a variety of surface versions underline the great versatility and variability available. The wardrobe interior fittings can be used in every kind of wardrobe – hinge-door, folding-door and sliding-door wardrobes as well as in the MULTI-FORMA II room system. There are many different sets of drawers for quick and easy planning.

Contents

	Page
Range introduction, list of versions	238
Fitted shelves, protective mat	239
Centre partition kits, clothes lift	240
Clothes rods, tie holders, trouser holders, inside mirror, fabric boxes	241
Important notes on fitting drawers in wardrobes	242-243
Sets of drawers	244-246
Fitting at any level	247-248
Accessories	249
Cover for sets of drawers	250
Wardrobe interior fittings in special width	251

Functional units

A multitude of functional components are the main features of the wardrobe interior fittings:

- Fitted shelves for straight and profiled units, also for panorama units and corner units
- Clothes rods for straight units and corner units
- LED illuminated shelves for straight units and hinge-door corner wardrobe, with automatic switch
- Centre partition kits and clothes lift
- Tie and trouser holders, also extendable
- Inside mirror for fitting on inside of wardrobe doors
- Fabric boxes

Drawers

For optimal use of wardrobes, all the drawers are available as single units or in sets. Because they can be fitted at any level it is possible to design wardrobe interior fittings individually.

- Drawers with wooden or glass front and shoe drawer
- Compartment for ties or linen for drawers with glass front
- Sets of drawers composed differently and made up of the units stated above
- For fitting at any level with carcasses, different drawers and accessories

Quality features

- **hülsta-SoftFlow:** All drawers on hidden roller bearings with auto pull-in feature with brake as fully pull-out units
- Tie holder in high-quality chrome version
- Drawer frames in standard grey
- Simple assembly due to the use of special brackets
- All inside surfaces have a side distance piece to ensure easy opening when the doors are open
- All wooden components optionally in different versions



List of versions

Model no.	Versions
973	White lacquer
974	Light interior veneer
975	Dark interior veneer

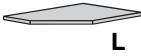
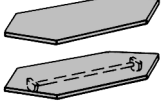
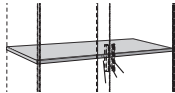
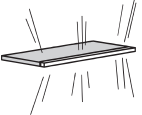
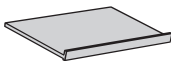

Please state in the order the name and the model number of the range which the wardrobe interior fittings are intended for.

Handle versions

The drawer handles for the wardrobe interior fittings are delivered standard in the same version as the wardrobe door handles in which the interior fittings are incorporated (high-gloss chrome or matt chrome). If the wardrobe door handles are required in wood or lacquer versions, please state the version of the drawer handles for the interior fittings clearly in the order!

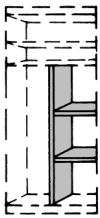
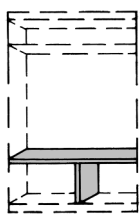
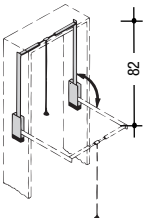
		for wardrobe inside widths	Type no.	
 <p>Fitted shelves 2.3 cm thick (2.6 cm thick, including support strut for 118 to 198 cm width)</p>  <p>L</p>	<ul style="list-style-type: none"> 28 cm wide components only in combination with centre partition kit <p>for straight units</p>	<ul style="list-style-type: none"> 28 cm 38 cm 48 cm 58 cm 68 cm 78 cm 88 cm 98 cm 108 cm 118 cm 128 cm 133 cm 138 cm 148 cm 158 cm 198 cm 	<p>79001 79002 79003 790032 790088 79004 79005 79006 790065 790068 790077 790066 790078 790067 79007 79008</p>	
	<p>for profiled end units from MULTI-FORMA II</p>	<ul style="list-style-type: none"> 48 cm 98 cm 	<p>790081 L 790082 R 790091 L 790092 R</p>	
 <p>Fitted corner shelf for 45° corner unit, 2.3 cm thick</p>	<p>without clothes rod</p>		<p>79020</p>	
	<p>with clothes rod</p>		<p>79021</p>	
<p>NEW</p>  <p>LED illuminated shelf 2.9 cm thick; with LED-lamp</p> <p>This luminaire contains built-in LED lamps of the energy classes A++ to A. The lamps cannot be changed in the luminaire. 12 V; 11.0 W</p>	<p>for straight units</p>	<ul style="list-style-type: none"> 98 cm 	<p>79436</p>	
 <p>LED illuminated shelf 2.9 cm thick; with LED-lamp; with automatic switch and motion detector</p> <p>We do not recommend fitting these illuminated shelves in the MULTI-FORMA II room system.</p> <p>This luminaire contains built-in LED lamps of the energy classes A++ to A. The lamps cannot be changed in the luminaire. 12 V; 3.4-18.7 W</p>	<p>for straight units</p>	<ul style="list-style-type: none"> 38 cm 48 cm 58 cm 68 cm 78 cm 88 cm 98 cm 108 cm 118 cm 128 cm 133 cm 138 cm 148 cm 158 cm 198 cm 	<p>79332 79333 793302 793038 79334 79335 79336 793365 793368 793377 793366 793378 793367 79337 79338</p>	
	<p>for hinge-door corner wardrobe</p> <p>without clothes rod</p>		<p>79339</p>	
	<p>with clothes rod</p>		<p>79340</p>	
 <p>Presentation shelf 2.3 cm thick; with extra slat on the front rim, 6.0 cm high Fitted height: approx. 17.5 cm when fitted at an angle</p>	<p>for straight units</p>	<ul style="list-style-type: none"> 48 cm 58 cm 68 cm 78 cm 88 cm 98 cm 108 cm 	<p>79503 79502 79508 79504 79505 79506 795065</p>	
 <p>Protective mat of silver-coloured plastic; for presentation shelves</p>	<p>for straight units</p>	<ul style="list-style-type: none"> 48 cm 58 cm 68 cm 78 cm 88 cm 98 cm 108 cm 	<p>79563 79562 79568 79564 79565 79566 795665</p>	

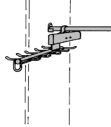
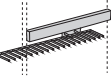
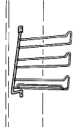
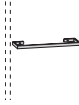
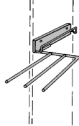
		for wardrobe inside widths	Type no.
 <p>Centre partition kit for wardrobes with unit inside widths of 78, 88 and 98 cm, consisting of: 1 centre partition (153.0 cm high); 2 constructional shelves 48 cm wide (fitted optionally left or right)</p> <p>for 78 cm width: 48 cm wide compartment with 2 constructional shelves; 28 cm open compartment</p> <p>for 88 cm width: 48 cm wide compartment with 2 constructional shelves; 38 cm open compartment</p> <p>for 98 cm width: 48 cm wide compartment with 2 constructional shelves; 48 cm open compartment</p> <p>Additional extras: 28, 38, 48 cm wide fitted shelves, clothes rods as well as 48 cm wide drawers and sets</p>			79130
<p>If the centre partition kit is fitted in the MULTI-FORMA II room system, please add a "1" to the type number (e.g. 7913641). Please state clearly in the order!</p>	1 Raster high Total height: 22.2 cm	138 cm 158 cm 198 cm	791364 791374 791384
 <p>Centre partition kit for hinge- and folding-door wardrobes as well as for open carcass units of the MULTI-FORMA II room system with unit inside widths of 138, 158 and 198 cm, consisting of: 1 centre partition (always in centre under constructional shelf) and 1 constructional shelf</p> <p>for 138 cm width: two 68 cm wide compartments for 158 cm width: two 78 cm wide compartments for 198 cm width: two 98 cm wide compartments</p> <p>Drawers and sets must be fitted in the centre partition kit (see pages 244-248). The standard cover shelves of the sets of drawers are deducted from the price.</p>	2 Raster high Total height: 41.4 cm	138 cm 158 cm 198 cm	791360 791370 791380
	3 Raster high Total height: 60.6 cm	138 cm 158 cm 198 cm	791361 791371 791381
	4 Raster high Total height: 79.8 cm	138 cm 158 cm 198 cm	791362 791372 791382
	5 Raster high Total height: 99.0 cm	138 cm 158 cm 198 cm	791363 791373 791383
 <p>Clothes lift Twin-arm, aluminium-coloured, swing-out clothes rod with brake mechanism Max. load: 10 kg</p>	for hinge-door wardrobes	68 cm 78 cm 98 cm 108 cm	79183 79184 79186 791865
	for folding- and sliding-door wardrobes	78 cm 88 cm 98 cm 108 cm 118 cm	78184 78185 78186 781865 781875

		for wardrobe inside widths	Type no.		
	<p>Clothes rod chrome, uniform tubular metal with two supports</p>	<ul style="list-style-type: none"> ● 28 cm wide components only in combination with centre partition kit <p>for straight units or for profiled end units</p>	<ul style="list-style-type: none"> ● 28 cm 38 cm 48 cm 58 cm 68 cm 78 cm 88 cm 98 cm 108 cm 118 cm 128 cm 133 cm 138 cm 148 cm 158 cm 198 cm 	<p>79011 79012 79013 790182 790018 79014 79015 79016 790165 790168 790177 790166 790178 790167 79017 79018</p>	
	<p>Extendable tie holder chrome, fitted on clothes rod and rear wall of wardrobe carcass for 22 ties 21.3 cm high, 11.6 cm wide, 50.0 cm deep</p>		79142		
	<p>Extendable tie holder chrome, fitted on the inner side of wardrobe carcass for 17 ties 13.0 cm high, 9.0 cm wide, 54.0 cm deep</p>		79145		
	<p>Tie holder chrome, fitted on the left inner side of wardrobe carcass for 18 ties 29.5 cm high, 25.0 cm wide, 8.0 cm deep</p>		79144		
	<p>Tie holder chrome, fitted on the inner side of hinge-doors for 3 ties 1.3 cm high, 26.0 cm wide, 5.0 cm deep</p>		79153		
	<p>Extendable trouser holder chrome, fitted on the inner side of wardrobe carcass for 3 pairs of trousers 26.0 cm high, 50.5 cm wide, 7.5 cm deep</p>		79146		
	<p>Inside mirror fitted on the inner side of 229.6 and 268.0 cm high as well as 40 and 50 cm wide, straight hinge-doors Please state clearly in the order which hinge-doors are to be fitted with an inside mirror. The inside mirror cannot be fitted in MULTI-FORMA II wardrobes in design F and F plus.</p>		79154		
	<p>Fabric boxes with leather grip; colours: black or sand 33.0 cm wide, 50.0 cm deep</p>	black	<p>8 cm high 16 cm high 24 cm high</p>	<p>79170 79171 79172</p>	
		sand	<p>8 cm high 16 cm high 24 cm high</p>	<p>79165 79166 79167</p>	

Important notes on fitting drawers in wardrobes

Additional accessories (e.g. drawers, sets of drawers, etc.; see pages **244-248**) can be fitted in hinge-, folding- and sliding-door wardrobes as well as in the MULTI-FORMA II room system. These accessories must always be fitted on both sides of the wardrobe side sections or centre partitions, i.e. the accessories have the same width as the inside width of the appropriate wardrobe unit (see examples **1** and **3-6**). It is, however, also possible to fit stand-alone accessories fitted at one side only. In this case, a cover for a set of drawers must be ordered extra (see examples **2, 7** and **8**). It is not possible to fit accessories that stand alone at both sides!

We differentiate between accessories for hinge-door wardrobes and for the MULTI-FORMA II room system as well as accessories for folding- and sliding-door wardrobes in the wardrobe interior fittings.

Drawers in the accessories for **hinge-door wardrobes** and for the **MULTI-FORMA II room system** are fitted with narrow side-support panels at both sides (see each of the left-hand wardrobe units in examples **1** and **2**).

Since folding- or sliding-doors cannot be opened at the sides as far as hinge-doors for constructional reasons, the accessories for **folding- and sliding-door wardrobes** are fitted with a narrow support panel at one side and with a wide support panel at the other side. That is why the accessories for folding- and sliding-door wardrobes are divided into accessories as "**accessories left**" = **L** (i.e. the wide side-support panel is fitted on the left-hand side of the accessory), and "**accessories right**" = **R** (i.e. the wide side-support panel is fitted on the right-hand side of the accessory).

With **folding-door wardrobes**, the wide support panel of the accessory must be fitted on the side of the folding-door unit where the folding-doors are mounted (see each of the middle and right-hand wardrobe units in examples **1** and **2** as well as example **3**). Please note: A sideward distance of up to a max. 5 cm must be kept to the side wall so that the folding-doors can be opened widely enough. The space depends on the intended handle. We recommend getting advice from hülsta if necessary.

With **2- and 4-door sliding-door wardrobes**, the wide support panel of the accessory must always be fitted on the inside of the sliding-door unit (see examples **4** and **6**). The same applies to the outside units of a **3-door sliding-door wardrobe**. The accessory of the middle unit must always be fitted with the wide support panel on the left (see example **5**). If the accessory is fitted as a stand-alone unit at one side with a cover for a set of drawers (see examples **2, 7** and **8**), the same applies as described above.

If 2 sets of drawers are fitted adjacently please use the centre partition kit shown on page **240** (see example **3**). The standard cover shelves of the sets of drawers are deducted from the price.

Please note: The sketches on pages **244-248** show the accessories for hinge-door wardrobes (i.e. with narrow side-support panels at both sides)!

Example 1 Hinge-/folding-door wardrobe

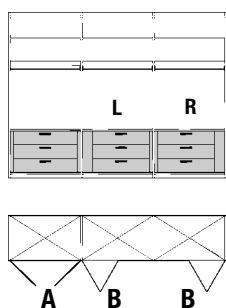

- A:** Accessory in hinge-door unit with narrow support panels at both sides
- B:** Accessory in folding-door unit with wide support panel at the side, where the door is mounted

Example 2 Hinge-/folding-door wardrobe

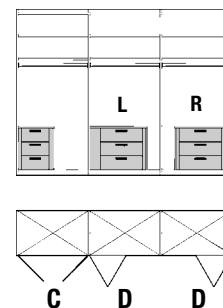

- C:** Accessory, stand-alone at one side, in hinge-door unit with narrow support panels at both sides
- D:** Accessory in folding-door unit, stand alone, at one side, with wide support panel at the side, where the door is mounted

Example 3

Folding-door wardrobe:
Panorama unit with 5 Raster high centre partition kit

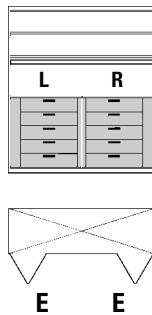

E: Accessory in folding-door wardrobe with wide support panel at the side, where the door is mounted

Example 4

2-door sliding-door wardrobe

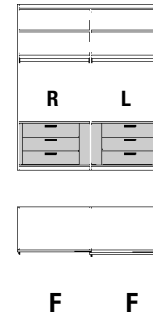

F: Accessory in sliding-door wardrobe with wide support panel at the side on the inside of the sliding-door unit

Example 5

3-door sliding-door wardrobe

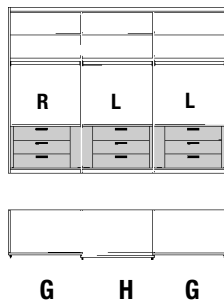

G: Accessory in sliding-door wardrobe with wide support panel at the side on the inside of the sliding-door unit
H: Accessory in sliding-door wardrobe in the centre unit with a standard wide support panel on the left-hand side

Example 6

4-door sliding-door wardrobe

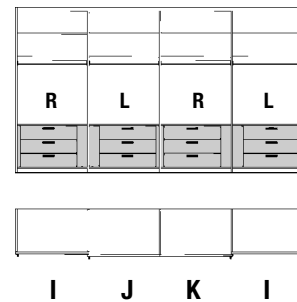

I: Accessory in sliding-door wardrobe with wide support panel at the side on the inside of the sliding-door unit
J: Accessory in sliding-door wardrobe in the left-hand centre unit with a standard wide support panel on the left-hand side
K: Accessory in sliding-door wardrobe in the right-hand centre unit with a standard wide support panel on the right-hand side

Example 7

2-door sliding-door wardrobe

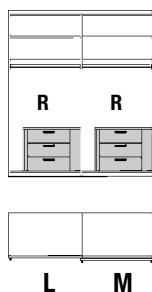

L: Accessory, stand-alone at one side, in sliding-door wardrobe with wide support panel at the side on the inside of the sliding-door unit
M: Since the accessory in the right-hand unit of the sliding-door wardrobe is mounted as a stand-alone unit on the side and does not reach as far as the inside wall of the sliding-door unit, the wide support panel can also be fitted on the outer side wall of the sliding-door unit.

Example 8



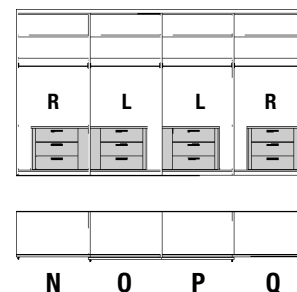



4-door sliding-door wardrobe



N: Accessory, stand-alone at one side, in sliding-door wardrobe with wide support panel at the side on the inside of the sliding-door unit
O: Accessory, stand-alone at one side, in sliding-door wardrobe in the left-hand centre unit with a standard wide support panel on the left-hand side
P: Accessory, stand-alone at one side, in sliding-door wardrobe in the right-hand centre unit with a standard wide support panel on the right-hand side
Q: Since the accessory in the right-hand unit of the sliding-door wardrobe is mounted as a stand-alone unit on the side and does not reach as far as the inside wall of the sliding-door unit, the wide support panel can also be fitted on the outer side wall of the sliding-door unit.







Sets of drawers

Sets of drawers as a complete unit consisting of top cover shelf, block sides and different drawers. If sets of drawers are stacked, the cover shelf of the bottom set of drawers is omitted and can be deducted from the price. A cover for a set of drawers must be fitted for mounting the units as stand-alone units at one side. If 2 sets of drawers are fitted adjacently please use the centre partition kit (see page 240). For fitting at any level and accessories: see pages 247-249!

Please state clearly in the order if the sets are to be fitted in a hinge-door wardrobe or in the MULTI-FORMA II room system!		for wardrobe inside widths	Type no. for hinge-door wardrobes and MULTI-FORMA II room system	Type no. for folding- and sliding-door wardrobes
	Set 1 1 drawer with wooden front Total height: 21.5 cm	48 cm 58 cm 68 cm 78 cm 88 cm 98 cm 108 cm	60013 60012 60018 60014 60015 60016 600166	- 610121 L 610122 R 610181 L 610182 R 610141 L 610142 R 610151 L 610152 R 610161 L 610162 R 6101661 L 6101662 R
	Set 2 1 drawer with glass front Total height: 21.5 cm	48 cm 58 cm 68 cm 78 cm 88 cm 98 cm 108 cm	60023 60022 60028 60024 60025 60026 600266	- 610221 L 610222 R 610281 L 610282 R 610241 L 610242 R 610251 L 610252 R 610261 L 610262 R 6102661 L 6102662 R
	Set 3 1 shoe drawer Total height: 40.7 cm	48 cm 58 cm 68 cm 78 cm 88 cm 98 cm 108 cm	- - 60038 60034 60035 60036 600366	- - - 610341 L 610342 R 610351 L 610352 R 610361 L 610362 R 6103661 L 6103662 R
	Set 4 2 drawers with wooden front Total height: 40.7 cm	48 cm 58 cm 68 cm 78 cm 88 cm 98 cm 108 cm	60043 60042 60048 60044 60045 60046 600466	- 610421 L 610422 R 610481 L 610482 R 610441 L 610442 R 610451 L 610452 R 610461 L 610462 R 6104661 L 6104662 R
	Set 5 1 drawer with glass front 1 drawer with wooden front Total height: 40.7 cm	48 cm 58 cm 68 cm 78 cm 88 cm 98 cm 108 cm	60053 60052 60058 60054 60055 60056 600566	- 610521 L 610522 R 610581 L 610582 R 610541 L 610542 R 610551 L 610552 R 610561 L 610562 R 6105661 L 6105662 R
	Set 6 2 drawers with glass front Total height: 40.7 cm	48 cm 58 cm 68 cm 78 cm 88 cm 98 cm 108 cm	60063 60062 60068 60064 60065 60066 600666	- 610621 L 610622 R 610681 L 610682 R 610641 L 610642 R 610651 L 610652 R 610661 L 610662 R 6106661 L 6106662 R

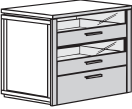
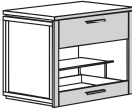

Sets of drawers

Sets of drawers as a complete unit consisting of top cover shelf, block sides and different drawers. If sets of drawers are stacked, the cover shelf of the bottom set of drawers is omitted and can be deducted from the price. A cover for a set of drawers must be fitted for mounting the units as stand-alone units at one side. If 2 sets of drawers are fitted adjacently please use the centre partition kit (see page 240). For fitting at any level and accessories: see pages 247-249!

Please state clearly in the order if the sets are to be fitted in a hinge-door wardrobe or in the MULTI-FORMA II room system!		for wardrobe inside widths	Type no. for hinge-door wardrobes and MULTI-FORMA II room system		Type no. for folding- and sliding-door wardrobes	
	Set 7 3 drawers with wooden front	Total height: 59.9 cm	48 cm 58 cm 68 cm 78 cm 88 cm 98 cm 108 cm 60073 60072 60078 60074 60075 60076 600766		- - 610721 L 610722 R 610781 L 610782 R 610741 L 610742 R 610751 L 610752 R 610761 L 610762 R 6107661 L 6107662 R	-
	Set 8 1 drawer with glass front 2 drawers with wooden front	Total height: 59.9 cm	48 cm 58 cm 68 cm 78 cm 88 cm 98 cm 108 cm 60083 60082 60088 60084 60085 60086 600866		- - 610821 L 610822 R 610881 L 610882 R 610841 L 610842 R 610851 L 610852 R 610861 L 610862 R 6108661 L 6108662 R	-
	Set 9 2 drawers with glass front 1 drawer with wooden front	Total height: 59.9 cm	48 cm 58 cm 68 cm 78 cm 88 cm 98 cm 108 cm 60093 60092 60098 60094 60095 60096 600966		- - 610921 L 610922 R 610981 L 610982 R 610941 L 610942 R 610951 L 610952 R 610961 L 610962 R 6109661 L 6109662 R	-
	Set 10 1 drawer with wooden front 1 shoe drawer	Total height: 59.9 cm	48 cm 58 cm 68 cm 78 cm 88 cm 98 cm 108 cm - - 60108 60104 60105 60106 601066	--	- - - - 611041 L 611042 R 611051 L 611052 R 611061 L 611062 R 6110661 L 6110662 R	---
	Set 11 4 drawers with wooden front	Total height: 79.1 cm	48 cm 58 cm 68 cm 78 cm 88 cm 98 cm 108 cm 60113 60112 60118 60114 60115 60116 601166		- - 611121 L 611122 R 611181 L 611182 R 611141 L 611142 R 611151 L 611152 R 611161 L 611162 R 6111661 L 6111662 R	-
	Set 12 1 drawer with glass front 3 drawers with wooden front	Total height: 79.1 cm	48 cm 58 cm 68 cm 78 cm 88 cm 98 cm 108 cm 60123 60122 60128 60124 60125 60126 601266		- - 611221 L 611222 R 611281 L 611282 R 611241 L 611242 R 611251 L 611252 R 611261 L 611262 R 6112661 L 6112662 R	-
	Set 13 2 drawers with glass front 2 drawers with wooden front	Total height: 79.1 cm	48 cm 58 cm 68 cm 78 cm 88 cm 98 cm 108 cm 60133 60132 60138 60134 60135 60136 601366		- - 611321 L 611322 R 611381 L 611382 R 611341 L 611342 R 611351 L 611352 R 611361 L 611362 R 6113661 L 6113662 R	-

Sets of drawers

Sets of drawers as a complete unit consisting of top cover shelf, block sides and different drawers. If sets of drawers are stacked, the cover shelf of the bottom set of drawers is omitted and can be deducted from the price. A cover for a set of drawers must be fitted for mounting the units as stand-alone units at one side. If 2 sets of drawers are fitted adjacently please use the centre partition kit (see page 240). For fitting at any level and accessories: see pages 247-249!

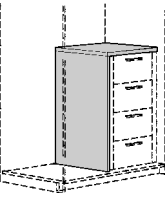
Please state clearly in the order if the sets are to be fitted in a hinge-door wardrobe or in the MULTI-FORMA II room system!		for wardrobe inside widths	Type no. for hinge-door wardrobes and MULTI-FORMA II room system	Type no. for folding- and sliding-door wardrobes
 <p>Set 14 5 drawers with wooden front</p>	Total height: 98.3 cm	48 cm	60143	-
		58 cm	60142	611421 L 611422 R
		68 cm	60148	611481 L 611482 R
		78 cm	60144	611441 L 611442 R
		88 cm	60145	611451 L 611452 R
		98 cm	60146	611461 L 611462 R
		108 cm	601466	6114661 L 6114662 R
 <p>Set 15 1 drawer with glass front 4 drawers with wooden front</p>	Total height: 98.3 cm	48 cm	60153	-
		58 cm	60152	611521 L 611522 R
		68 cm	60158	611581 L 611582 R
		78 cm	60154	611541 L 611542 R
		88 cm	60155	611551 L 611552 R
		98 cm	60156	611561 L 611562 R
		108 cm	601566	6115661 L 6115662 R
 <p>Set 16 2 drawers with glass front 3 drawers with wooden front</p>	Total height: 98.3 cm	48 cm	60163	-
		58 cm	60162	611621 L 611622 R
		68 cm	60168	611681 L 611682 R
		78 cm	60164	611641 L 611642 R
		88 cm	60165	611651 L 611652 R
		98 cm	60166	611661 L 611662 R
		108 cm	601666	6116661 L 6116662 R
 <p>Cover for sets of drawers</p> <p>The cover for sets of drawers is necessary when sets of drawers are fitted as stand-alone units at one side in the wardrobe (example: a 48 cm wide set is fitted in a wardrobe with an inside width of 98 cm so that one side of the set is fitted on the interior side of the wardrobe and the other side of the set stands alone in the wardrobe centre).</p> <p>See here page 250!</p>				

Fitting at any level

Besides being able to fit complete sets of drawers, it is also possible to plan wardrobe interior fittings individually. All carcasses, consisting of the top cover shelf and block sides, can be fitted individually with different drawers. A cover for a set of drawers must be fitted for mounting the units as stand-alone units at one side in a wardrobe. If 2 carcasses are fitted adjacently, the centre partition kit must be used (see page 240). Complete sets of drawers: see pages 244-246! Accessories: see page 249!

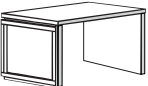
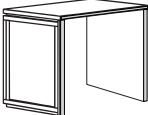
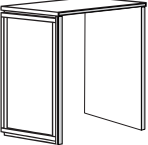
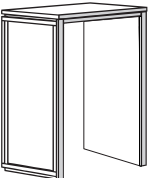
Please state clearly in the order if the carcasses are to be fitted in a hinge-door wardrobe or in the MULTI-FORMA II room system!		for wardrobe inside widths	Type no. for hinge-door wardrobes and MULTI-FORMA II room system	Type no. for folding- and sliding-door wardrobes
	1 Raster carcass Total height: 21.5 cm	48 cm 58 cm 68 cm 78 cm 88 cm 98 cm 108 cm	40013 40012 40018 40014 40015 40016 400166	- 410121 L 410122 R 410181 L 410182 R 410141 L 410142 R 410151 L 410152 R 410161 L 410162 R 4101661 L 4101662 R
	2 Raster carcass Total height: 40.7 cm	48 cm 58 cm 68 cm 78 cm 88 cm 98 cm 108 cm	40023 40022 40028 40024 40025 40026 400266	- 410221 L 410222 R 410281 L 410282 R 410241 L 410242 R 410251 L 410252 R 410261 L 410262 R 4102661 L 4102662 R
	3 Raster carcass Total height: 59.9 cm	48 cm 58 cm 68 cm 78 cm 88 cm 98 cm 108 cm	40033 40032 40038 40034 40035 40036 400366	- 410321 L 410322 R 410381 L 410382 R 410341 L 410342 R 410351 L 410352 R 410361 L 410362 R 4103661 L 4103662 R
	4 Raster carcass Total height: 79.1 cm	48 cm 58 cm 68 cm 78 cm 88 cm 98 cm 108 cm	40043 40042 40048 40044 40045 40046 400466	- 410421 L 410422 R 410481 L 410482 R 410441 L 410442 R 410451 L 410452 R 410461 L 410462 R 4104661 L 4104662 R
	5 Raster carcass Total height: 98.3 cm	48 cm 58 cm 68 cm 78 cm 88 cm 98 cm 108 cm	40053 40052 40058 40054 40055 40056 400566	- 410521 L 410522 R 410581 L 410582 R 410541 L 410542 R 410551 L 410552 R 410561 L 410562 R 4105661 L 4105662 R

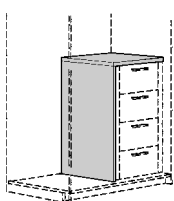

Cover for sets of drawers

The cover for sets of drawers is necessary when carcasses are fitted as stand-alone units at one side in the wardrobe (example: a 48 cm wide carcass is fitted in a wardrobe with an inside width of 98 cm so that one side of the carcass is fitted on the interior side of the wardrobe and the other side of the carcass stands alone in the wardrobe centre).

See here page 250!

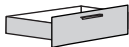
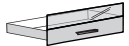
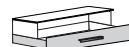

Fitting at any level

Besides being able to fit complete sets of drawers, it is also possible to plan wardrobe interior fittings individually. All carcasses, consisting of the top cover shelf and block sides, can be fitted individually with different drawers. A cover for a set of drawers must be fitted for mounting the units as stand-alone units at one side in a wardrobe. If 2 carcasses are fitted adjacently, the centre partition kit must be used (see page 240). Complete sets of drawers: see pages 244-246! Accessories: see page 249!

		for wardrobe inside widths	Type no. for hinge-door wardrobes and MULTI-FORMA II room system		Type no. for folding- and sliding-door wardrobes		
	1 Raster drawer with wooden front	19.2 cm high	48 cm 58 cm 68 cm 78 cm 88 cm 98 cm 108 cm	49263 49262 49268 49264 49265 49266 492666		- 49263 49268 49264 49265 49266	-
	1 Raster drawer with glass front	19.2 cm high	48 cm 58 cm 68 cm 78 cm 88 cm 98 cm 108 cm	49273 49272 49278 49274 49275 49276 492766		- 49273 49272 49278 49274 49275 49276	-
	2 Raster shoe drawer with metal shelf; fits approx. shoe size 46	38.4 cm high	48 cm 58 cm 68 cm 78 cm 88 cm 98 cm 108 cm	- - 49208 49204 49205 49206 492066	--	- - - 49208 49204 49205 49206	---

Accessories

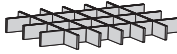
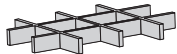
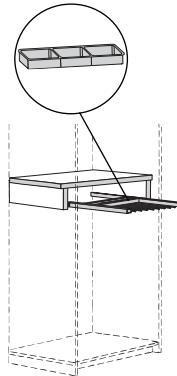
The drawers in the sets of drawers and the carcasses for fitting at any level can be fitted with drawer compartments. The pull-out trouser holder is meant for fitting on the inner side of the wardrobe. The storage bowl enhances the pull-out trouser holder in the form of an additional extra.

	for wardrobe inside widths	Type no. for hinge-door wardrobes and MULTI-FORMA II room system	Type no. for folding- and sliding-door wardrobes																											
 <p>Compartment for ties We recommend only fitting these compartments in drawers with glass fronts. 5.6 cm high</p> <table border="1"> <thead> <tr> <th colspan="3">Number of compartments for ties:</th> </tr> <tr> <th>for wardrobe inside width:</th> <th>Hinge-doors/ room system</th> <th>Folding-doors/ sliding-doors</th> </tr> </thead> <tbody> <tr><td>48 cm</td><td>12</td><td>-</td></tr> <tr><td>58 cm</td><td>16</td><td>12</td></tr> <tr><td>68 cm</td><td>20</td><td>16</td></tr> <tr><td>78 cm</td><td>24</td><td>20</td></tr> <tr><td>88 cm</td><td>28</td><td>24</td></tr> <tr><td>98 cm</td><td>32</td><td>28</td></tr> <tr><td>108 cm</td><td>32</td><td>32</td></tr> </tbody> </table>	Number of compartments for ties:			for wardrobe inside width:	Hinge-doors/ room system	Folding-doors/ sliding-doors	48 cm	12	-	58 cm	16	12	68 cm	20	16	78 cm	24	20	88 cm	28	24	98 cm	32	28	108 cm	32	32	48 cm 58 cm 68 cm 78 cm 88 cm 98 cm 108 cm	49283 49282 49288 49284 49285 49286 492866	- 49283 49282 49288 49284 49285 49286
Number of compartments for ties:																														
for wardrobe inside width:	Hinge-doors/ room system	Folding-doors/ sliding-doors																												
48 cm	12	-																												
58 cm	16	12																												
68 cm	20	16																												
78 cm	24	20																												
88 cm	28	24																												
98 cm	32	28																												
108 cm	32	32																												
 <p>Compartment for linen We recommend only fitting these compartments in drawers with glass fronts. 5.6 cm high</p> <table border="1"> <thead> <tr> <th colspan="3">Number of compartments for linen:</th> </tr> <tr> <th>for wardrobe inside width:</th> <th>Hinge-doors/ room system</th> <th>Folding-doors/ sliding-doors</th> </tr> </thead> <tbody> <tr><td>48 cm</td><td>6</td><td>-</td></tr> <tr><td>58 cm</td><td>9</td><td>6</td></tr> <tr><td>68 cm</td><td>12</td><td>9</td></tr> <tr><td>78 cm</td><td>15</td><td>12</td></tr> <tr><td>88 cm</td><td>15</td><td>15</td></tr> <tr><td>98 cm</td><td>15</td><td>15</td></tr> <tr><td>108 cm</td><td>15</td><td>15</td></tr> </tbody> </table>	Number of compartments for linen:			for wardrobe inside width:	Hinge-doors/ room system	Folding-doors/ sliding-doors	48 cm	6	-	58 cm	9	6	68 cm	12	9	78 cm	15	12	88 cm	15	15	98 cm	15	15	108 cm	15	15	48 cm 58 cm 68 cm 78 cm 88 cm 98 cm 108 cm	49293 49292 49298 49294 49295 49296 492966	- 49293 49292 49298 49294 49295 49296
Number of compartments for linen:																														
for wardrobe inside width:	Hinge-doors/ room system	Folding-doors/ sliding-doors																												
48 cm	6	-																												
58 cm	9	6																												
68 cm	12	9																												
78 cm	15	12																												
88 cm	15	15																												
98 cm	15	15																												
108 cm	15	15																												
 <p>Pull-out trouser holder incl. top wooden cover shelf, block sides and storage bowl (storage bowl in 3 compartments, 2.7 cm high, 24.3 cm wide, 10.7 cm deep, of grey plastic, resting in rear area of trouser holder); for fitting on inner side of wardrobe at 98.3 cm height Total height of pull-out trouser holder including cover shelf: 21.5 cm; block 19.2 cm high, 55.0 cm deep</p> <table border="1"> <thead> <tr> <th colspan="3">Number of compartments for trousers / number of storage bowls:</th> </tr> <tr> <th>for wardrobe inside width:</th> <th>Hinge-doors/ room system</th> <th>Folding-doors/ sliding-doors</th> </tr> </thead> <tbody> <tr><td>68 cm</td><td>10 / 1</td><td>-</td></tr> <tr><td>78 cm</td><td>12 / 2</td><td>10 / 1</td></tr> <tr><td>88 cm</td><td>14 / 2</td><td>12 / 2</td></tr> <tr><td>98 cm</td><td>16 / 2</td><td>14 / 2</td></tr> <tr><td>108 cm</td><td>-</td><td>16 / 2</td></tr> </tbody> </table>	Number of compartments for trousers / number of storage bowls:			for wardrobe inside width:	Hinge-doors/ room system	Folding-doors/ sliding-doors	68 cm	10 / 1	-	78 cm	12 / 2	10 / 1	88 cm	14 / 2	12 / 2	98 cm	16 / 2	14 / 2	108 cm	-	16 / 2	68 cm 78 cm 88 cm 98 cm 108 cm	40008 40004 40005 40006 -	- - 410041 L 410042 R 410051 L 410052 R 410061 L 410062 R 4100661 L 4100662 R						
Number of compartments for trousers / number of storage bowls:																														
for wardrobe inside width:	Hinge-doors/ room system	Folding-doors/ sliding-doors																												
68 cm	10 / 1	-																												
78 cm	12 / 2	10 / 1																												
88 cm	14 / 2	12 / 2																												
98 cm	16 / 2	14 / 2																												
108 cm	-	16 / 2																												
<p>If the cover shelf is fitted in the MULTI-FORMA II room system, please add a "1" to the type number (e.g. 492531). Please state clearly in the order!</p>  <p>Cover shelf 2.3 cm thick</p>	48 cm 58 cm 68 cm 78 cm 88 cm 98 cm 108 cm	49253 49252 49258 49254 49255 49256 492566	49253 49252 49258 49254 49255 49256 492566																											

Cover for sets of drawers

(stand-alone at one side); consisting of block sides and a top cover shelf. The cover for sets of drawers is necessary when sets of drawers and carcasses are fitted as stand-alone units at one side in the wardrobe (example: a 48 cm wide set is fitted in a wardrobe with an inside width of 98 cm so that one side of the set is fitted on the interior side of the wardrobe and the other side of the set stands alone in the wardrobe centre). Note: The standard cover shelf of the sets of drawers or carcasses is automatically removed from the set or carcass. The cost of the special cover for the set of drawers or carcasses is offset against the cost of this standard cover.

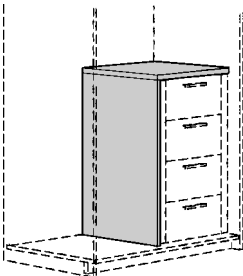
If the cover for sets of drawers is to be fitted in the MULTI-FORMA II room system, please add a "1" to the type number (e.g. 404131). Please state clearly in the order!		for wardrobe inside widths	Type no. for hinge-door wardrobes and MULTI-FORMA II room system	Type no. for folding- and sliding-door wardrobes
 <p>Cover for sets of drawers</p>	for 1 Raster height	48 cm 58 cm 68 cm 78 cm 88 cm 98 cm 108 cm	40413 40412 40418 40414 40415 40416 404166	40413 40412 40418 40414 40415 40416 404166
	for 2 Raster height	48 cm 58 cm 68 cm 78 cm 88 cm 98 cm 108 cm	40423 40422 40428 40424 40425 40426 404266	40423 40422 40428 40424 40425 40426 404266
	for 3 Raster height	48 cm 58 cm 68 cm 78 cm 88 cm 98 cm 108 cm	40433 40432 40438 40434 40435 40436 404366	40433 40432 40438 40434 40435 40436 404366
	for 4 Raster height	48 cm 58 cm 68 cm 78 cm 88 cm 98 cm 108 cm	40443 40442 40448 40444 40445 40446 404466	40443 40442 40448 40444 40445 40446 404466
	for 5 Raster height	48 cm 58 cm 68 cm 78 cm 88 cm 98 cm 108 cm	40453 40452 40458 40454 40455 40456 404566	40453 40452 40458 40454 40455 40456 404566

Wardrobe interior fittings in special width

In order to exploit the area available inside the wardrobes in special width optimally, it is also possible to order the wardrobe interior fittings in special width for these units.

Cover shelf and side panels in special width type 99911
See below for two examples of calculation!

Hinge-door wardrobes and MULTI-FORMA II room system

The standard sets of drawers and carcasses for fitting at any level in hinge-door wardrobes and in the MULTI-FORMA II room system have slim 4.5 cm wide side panels fitted at both sides (see here pages 242-243). These panel sizes are different in the case of wardrobe interior fittings in special width.

If a hinge-door wardrobe, for example, is required in the special wardrobe inside width of 64 cm, the wardrobe interior fittings must be fitted in the next smaller standard size – that means the required wardrobe interior fittings are in a width of 58 cm. The difference in width of 6 cm that results is balanced out by making the 4.5 cm wide side panels 3 cm wider (= 7.5 cm each).

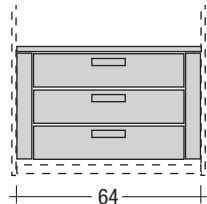

Special wardrobe inside width of 64 cm

64

Standard width of wardrobe interior fittings of 58 cm

58

The panel width now comes to 7.5 cm each

3 4.5	4.5 3
+++	+++
7,5	7,5

Folding-door and sliding-door wardrobes

The standard sets of drawers and carcasses for fitting at any level in folding- and sliding-door wardrobes are fitted with a slim 4.5 cm wide side panel at one side and a wide 14.5 cm wide side panel at the other side (see here pages 242-243). The panel size of the slim panel is different in the case of wardrobe interior fittings in special width.

If a folding-door wardrobe, for example, is required in the special wardrobe inside width of 82 cm, the wardrobe interior fittings must be fitted in the next smaller standard size – that means the required wardrobe interior fittings are in a width of 78 cm. The difference in width of 4 cm that results is balanced out by making the 4.5 cm wide side panel 4 cm wider (= 8.5 cm), the 14.5 cm wide side panel always retains its original width.

L/R = left/right (see here pages 242-243)

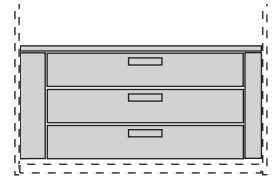

Special wardrobe inside width of 82 cm

82

Standard width of wardrobe interior fittings of 78 cm

78

Large side panel width always remains in original size of 14.5 cm, the slim side panel width is now 8.5 cm

+++	4,5 4
14,5	+++
	8,5

Switch options for lamps: Magic-Tronic

Magic-Tronic

The lamps are normally operated by an external footswitch. As an alternative we can also provide a Magic-Tronic switch, which is charged extra. By “stroking” the outer or top side of the unit at the same level as the invisible integrated sensor it is possible to switch all the lamps on and off (“Stroking method”). As an alternative the position of the hidden sensor can also be marked with a small metal plate on the furniture unit (“Marking method”). Lamps with a maximum power of 200 W can be operated by a Magic-Tronic unit (230 V). The footswitch is omitted when a Magic-Tronic unit is included.

Standard position of Magic-Tronic for angled shelves:

- for angled shelves of the CUTARO and METIS plus ranges: sensor is fitted **8 cm from the top rim and 8 cm from the left side in the rear wall panel**
- for angled shelves of the LUNIS range: sensor is fitted **16 cm from the rear rim and 9.6 cm from the left side in the shelf**

Standard position of Magic-Tronic for consoles and chests:

- for consoles and chests of the ELUMO II and LUNIS ranges: sensor is fitted **16 cm from the rear rim in the cover shelf and 15.0 cm at the side next to the bed**
- for consoles and chests of the MULTI-VARIS range: sensor is fitted **12 cm from the rear rim in the outer side next to the bed and in approx. 7-15 cm from the top rim of the unit**

Standard position of Magic-Tronic for MULTI-FORMA II wardrobes:

- for hinge- and folding-door wardrobes of the MULTI-FORMA II range: sensor is fitted **in the right passepartout in approx. 130 cm height** (Magic-Tronic is not possible for wardrobes without passepartout, in sliding-door wardrobes and in the room and niche system)

Alternative positions:

If the Magic-Tronic sensor is to be fitted **on the right in the rear wall panel or in the shelf of angled shelves**, in the **left passepartout of the wardrobe** or **at any position other than that stated as standard** (e.g., if a unit is planned in a niche so that there is insufficient space to the right of the unit), **please state this clearly in the order and mark the position in the sketch. If in doubt, please contact your hülsta customer advisor!**

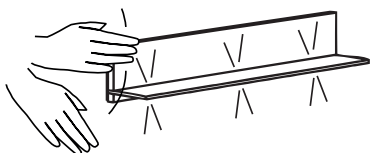

Illustration 1: “Stroking method“

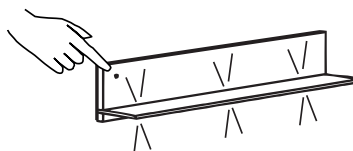

Illustration 2: “Marking method“

Magic-Tronic

7617

Switch options for lamps: Magic-Tronic

Examples of use (schematic diagrams)

Example 1

Black point = Standard position of Magic-Tronic sensor for angled shelves

Notes:

The black point in the drawings is the area where the Magic-Tronic sensor is invisibly integrated. If the surface is „stroked“ at this position, the lamps are switched on or off.

If you would like to mark the position of the Magic-Tronic sensor on the furniture, you can fit a small metal plate supplied separately at the corresponding position.

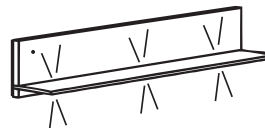

for angled shelves of the CUTARO and METIS plus ranges

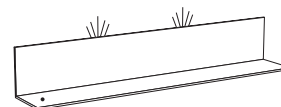

for angled shelves of the LUNIS range

Example 2

Black point = Standard position of Magic-Tronic sensor for consoles and chests

Notes:

The black point in the drawings is the area where the Magic-Tronic sensor is invisibly integrated. If the surface is „stroked“ at this position, the lamps are switched on or off.

If you would like to mark the position of the Magic-Tronic sensor on the furniture, you can fit a small metal plate supplied separately at the corresponding position.

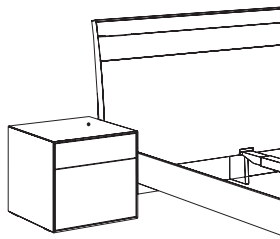

for consoles and chests of the ELUMO II and LUNIS ranges

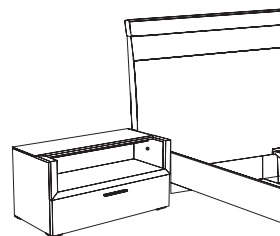

for consoles and chests of the MULTI-VARIS range

Example 3

Black point = Standard position of Magic-Tronic sensor for hinge- and folding-door wardrobes of the MULTI-FORMA II range

Notes:

The black point in the drawings is the area where the Magic-Tronic sensor is invisibly integrated. If the surface is „stroked“ at this position, the lamps are switched on or off.

If you would like to mark the position of the Magic-Tronic sensor on the furniture, you can fit a small metal plate supplied separately at the corresponding position.

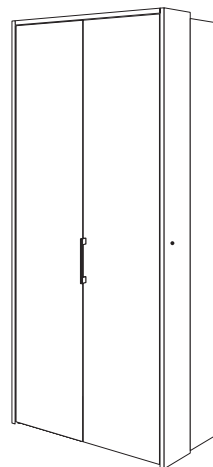

for hinge- and folding-door wardrobes of the MULTI-FORMA II range

Remote control unit with changing colours

The lamps are normally operated by an external footswitch. The colour temperature of the LED lamps is cold white if a footswitch is used. A 4-channel remote control unit (= transmitter), which is charged extra, is also available as an alternative. Several lamps (up to a total load of a maximum 30 W per transformer and receiver) can be operated with each of the 4 channels. All 4 channels can be dimmed separately at the push of a button. The colour temperature of all 4 channels can be set from cold white (= the basic setting of the LED lamps) to warm white. If warm white is required, a radio remote control unit must be ordered. It is also possible to switch all channels on and off simultaneously with the "all on" or "all off" buttons. Up to 4 transmitters can operate as many receivers as required. Transmitters and receivers must be ordered separately. The footswitch is omitted when the remote control unit is used.

The following points must be noted with the radio remote control unit:

- The receiver must be positioned behind a rear wall or under plinth shelves (at least 20 mm space required under plinth shelves).
- The total wattage power of all lamps included per power supply unit/receiver must not exceed 30 W.
- 4 channels = 4 light groups
- 1 light group = x lights
- All lamps within a light group can be dimmed to the same brightness.
- The same light colour can be set for all lamps in all the light groups. This light colour is then valid for all the lamps.
- The remote control unit is not suitable for equipment operating on 110 V!

Important notes:

The information on basic settings for the LED lamps as well as setting the colour temperature do not apply to the MEGA-DESIGN and MULTI-VARIS ranges!
Please be sure to note the operating and programming instructions!

4-channel remote control unit with changing colours

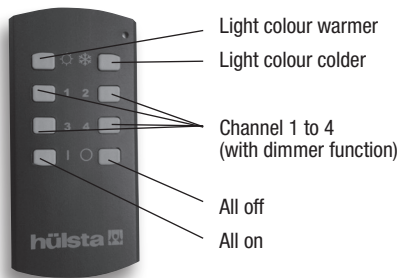

4-channel remote control unit with changing colours

Price per transmitter	type	2016
Price per receiver	type	2017

Switch options for lamps: Remote control unit with changing colours

Examples of use (schematic diagrams)

Example 1

Lights inside a unit

Channel 1 operates (and dims) all the lights in light group 1, i.e. the spotlamp in the left cabinet

Channel 2 operates (and dims) all the lights in light group 2, i.e. the spotlamps in the unit above the TV bench

Channel 3 operates (and dims) all the lights in light group 3, i.e. the spotlamp in the right cabinet

Required are:

1 transmitter 1x type **2016**
1 receiver 1x type **2017**

Notes:

The total wattage power of all lamps included per power supply unit/receiver must not exceed 30 W. The same light colour can be set for all lamps in all the light groups. This light colour is then valid for all the lamps.

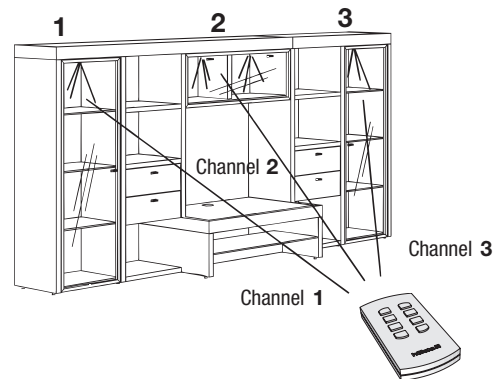

Example 2

Lights in units set apart

Channel 1 operates (and dims) all the lights in light group 1, i.e. the spotlamp and the light panels in the left cabinet

Channel 2 operates (and dims) all the lights in light group 2, i.e. the light panels and the spotlamps in the centre cabinet

Channel 3 operates (and dims) all the lights in light group 3, i.e. the spotlamp in the right cabinet

Required are:

1 transmitter 1x type **2016**
3 receivers 3x type **2017**

Notes:

The total wattage power of all lamps included per power supply unit/receiver must not exceed 30 W. The same light colour can be set for all lamps in all the light groups. This light colour is then valid for all the lamps.

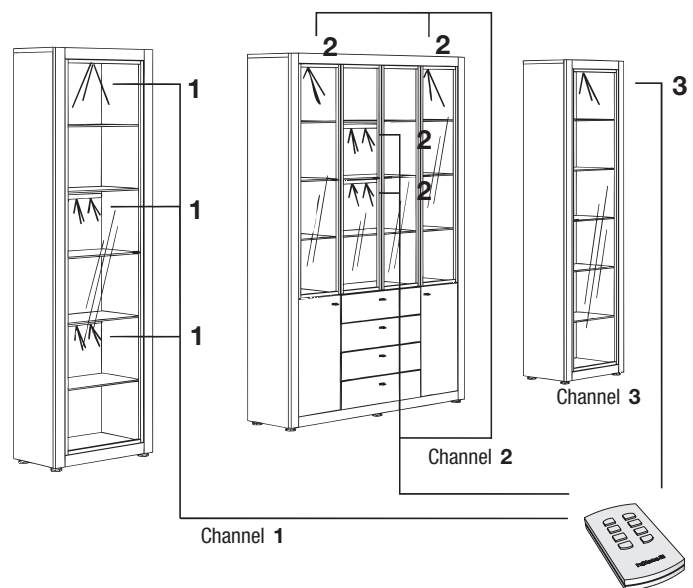

Example 3

Lights in units set apart

Channel 1 operates (and dims) all the lights in light group 1, i.e. the spotlamps in the left, centre and right cabinet

Channel 2 operates (and dims) all the lights in light group 2, i.e. the top light panels in the left, centre and right cabinet

Channel 3 operates (and dims) all the lights in light group 3, i.e. the bottom light panels in the left, centre and right cabinet

Required are:

1 transmitter 1x type **2016**
3 receivers 3x type **2017**

Notes:

The total wattage power of all lamps included per power supply unit/receiver must not exceed 30 W. The same light colour can be set for all lamps in all the light groups. This light colour is then valid for all the lamps.

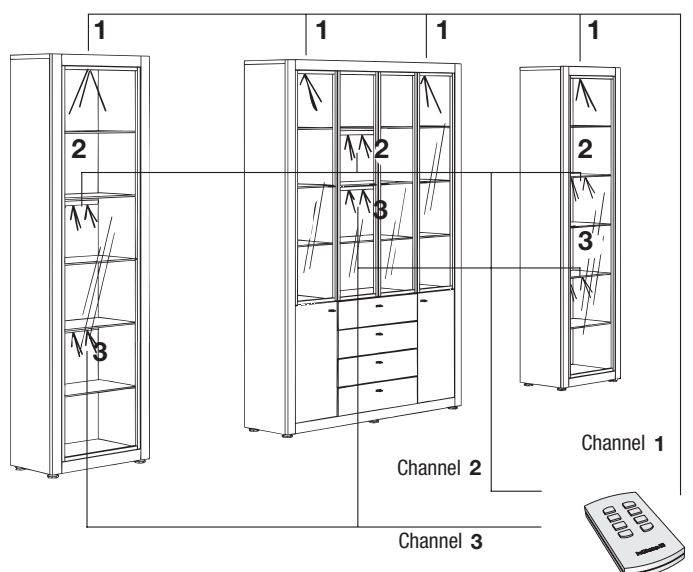

Usable bed inside height and space under bed

Note on usable bed inside height:

The support slats of the hülsta beds are delivered in the centre position, i.e. they can be adjusted by 3.2 cm upwards and downwards (exception: for LUNIS beds in the standard surface height 1 only by 3.2 cm upwards. If the slats are set in the lowest position, the **maximum usable bed inside height** is achieved.

In the case of some beds, especially the design-oriented beds, the bed inside height is comparatively low. This means that mattresses in combination with base frames that are somewhat higher (e.g. base frames with motor drive) are not held so well by the bed side sections. Please note that the usable bed inside height of beds with height adjustable support slats is reduced when these are set higher.

This is how to calculate the individual height from the data supplied with the base frames:

Example (for all beds): ELUMO II bed and hülstaflex basic B base frame (back and foot sections adjustable)

Max. usable bed inside height:
18.0 cm

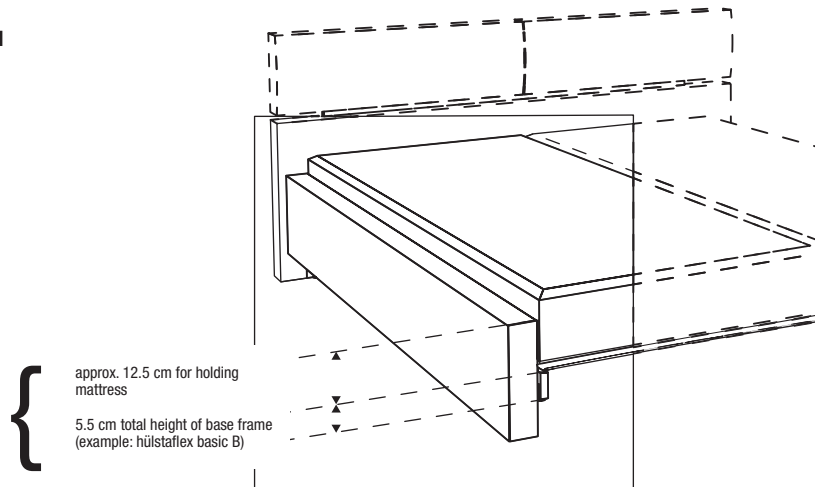

LUNIS bed in standard surface height 1 and hülstaflex basic B base frame (back and foot sections adjustable)

Max. usable bed inside height:
14.0 cm

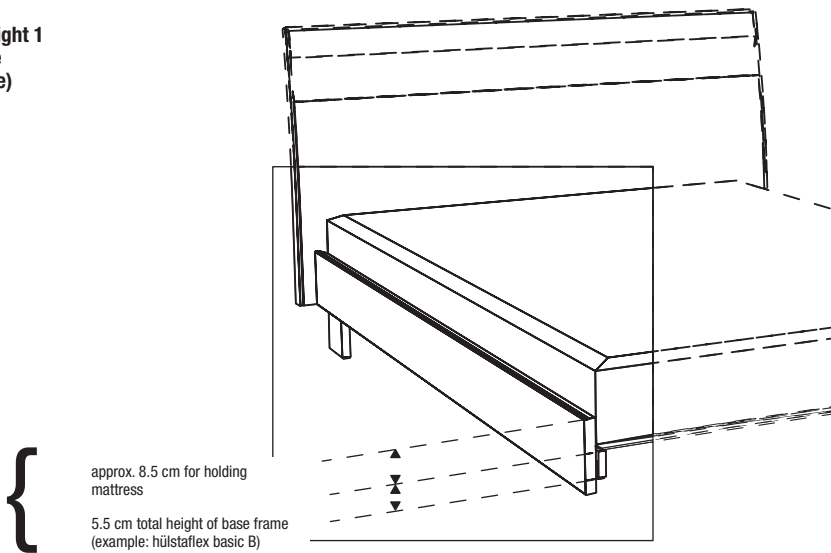

Note on space under bed:

The storage space underneath the base frame is calculated from the bed height minus the usable bed inside height.

Example ELUMO II bed: **42.2 cm - 18.0 cm = 24.2 cm.**

A space of 15 cm below the bed is necessary for hülsta base frames with motor drives. This is guaranteed in nearly all hülsta beds. With hülstaflex premium Motor the motor lies above the support slats: greatest amount of space possible.

SPECIAL WISHES? COME TO US!

Maximum individuality!
Maximal flexibility!
hülsta makes most of your special wishes possible.

High-quality furnishing is an expression of your individuality and personality.

hülsta has perfected this idea. We have developed some innovative production systems, which can fulfil more special wishes than ever before. And it makes no difference what range you are thinking of. We will try everything to put your ideas into practice.

There are already a lot of special products available for ordering from the hülsta type lists to make things as easy for you as possible.

And if you do have a wish which is not quite so easy to implement, just give us a call or send us a mail or a fax. We have our own hülsta "Special Wishes Team" who are there to help you realise just these customer requests.

These colleagues are professionals when it comes to special products. They plan and calculate the possible products for you and even develop an alternative suggestion if the idea should turn out to be technically impossible.

Here is an overview of the hülsta range of special wishes:

- A lot of special products can simply be ordered via the type lists
- Special products are planned simply and professionally
- Competent colleagues advise you by phone, by fax and by mail
- You will be sent alternative suggestions if the idea is technically impossible
- Many special products are available without a surcharge
- Specially qualified carpenters and technicians implement your plans perfectly

Something missing? Then simply contact us. Our "Special Wishes Team" can make almost anything possible. And if you should happen to present us with an impossible case – no problem. You will be sent a good alternative suggestion which is sure to work.

CONTACT US:
Tel.: +49 (0) 2563 / 86-0
Fax: +49 (0) 2563 / 86-1417
Mail: sonderwunsch@huelsta.com
Mon. - Sat.: 9.00 until 18.00

Special heights, special widths, special depths

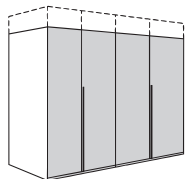

Special heights

Hinge-, folding- and sliding-door wardrobes can be reduced in height at intervals of 1.0 cm.

Special heights in stepped versions (not possible on sliding-door wardrobes) at a surcharge: surcharge per step:

Below eye-level we recommend fitting a top cover shelf made of panelling material. Please state in order!

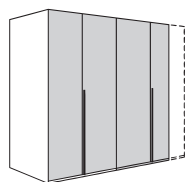

Special widths

Only applies to hinge- and folding-door wardrobes.

Single-door units, left or right hinges, can be reduced down to 25 cm width (apart from profiled doors).

Twin-door units can be reduced at both sides down to 50 cm total width (apart from profiled doors).

Interior fittings, such as drawers and other fittings cannot be reduced in width.

For notes on width reductions on MULTI-FORMA II sliding-door wardrobes please see special-sized products for MULTI-FORMA II!

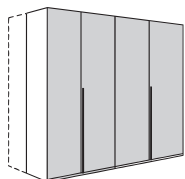

Special depths

Depth reductions are made on side sections, plinths, cornices and shelves.

Interior fittings, such as drawers and other fittings cannot be reduced in depth.

A max. reduction of 30.0 cm is possible on hinge- and folding-door wardrobes.

A max. reduction of 9.0 cm is possible on profiled hinge-doors.

For sliding-door wardrobes, a max. reduction of 30.0 cm is possible (max. 18 cm in combination with the electrical opening system for MULTI-FORMA II).

Please note that for technical production reasons not every special depth can be achieved:

2.5 cm standard reduction between 0 and 2.5 cm

5.0 cm standard reduction between 4.5 and 5.0 cm

27.5 cm standard reduction between 27.0 and 27.5 cm

Side and rear sloping

Notes on calculating sizes of sloping units

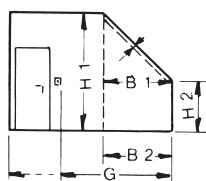
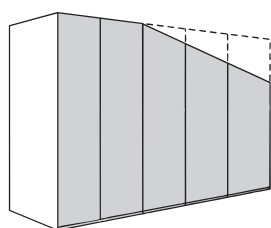

Side sloping

Sloping is only possible on single-door units. The door hinge (left or right) is positioned on the taller outer side of the unit.

Measurements required:

- H 1 = Room height
- H 2 = Height of slope
(If a space is required between the wall and the wardrobe/unit, please state the exact distance.)
- B 1 = Width of slope
- B 2 = Width of slope
- G = Total width
- S = Wardrobe width

Please note!

- If the slope cuts across the position of a handle, the handle of this door only is positioned further down in production.
- As floors, ceilings and walls are never exactly straight, the exact room size must be measured using a spirit level.
- If a cornice is fitted, please state if this is to be continued in the sloping section.
- For CUTARO and ELUMO II wardrobes with a passepartout section, the passepartout for the complete wardrobe is set back by 2 cm (no forward protruding any more).

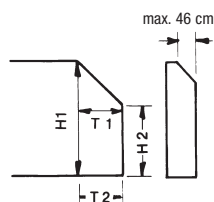
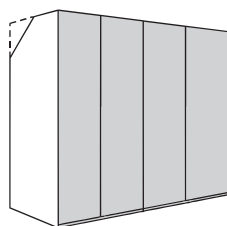

Rear sloping

Rear sloping is possible on all wardrobe units.

Measurements required:

- H 1 = Room height
- H 2 = Height of slope
(If a space is required between the wall and the wardrobe/unit, please state the exact distance.)
- T 1 = Depth of slope
- T 2 = Depth of slope

CUTARO

Wardrobes

Special heights:

Hinge-door	- Wood	0003	no surcharge
Hinge-door	- Mirror	00031	no surcharge

Special widths (not possible on high-gloss fronts):

for single-door unit	- Wood	0005
for single-door unit	- Mirror	00051
for twin-door unit	- Wood	0006
for twin-door unit	- Mirror	00061

When ordering extra fitted shelves and clothes rods

Size reduction surcharge per fitted shelf	9991
Size reduction surcharge per clothes rod	9992

Special depths:

Surcharge per unit	0007
--------------------	------

When ordering extra fitted shelves

Size reduction surcharge per fitted shelf	9993
---	------

Side sloping:

Surcharge per unit without passepartout in the slope	9994
--	------

Surcharge per unit with passepartout in the slope	99916
---	-------

Rear sloping:

Surcharge per unit	99912
--------------------	-------

Ancillary units

Special heights (doors with design fractal and drawers not possible in special height):

Carcase	99902
Door	99903
Chest of drawers in drawer raster	99902

Special widths (drawers with design fractal not possible in special width):

Carcase	999120
Door	999130
Drawer	999170

When ordering extra fitted shelves

Size reduction surcharge per fitted shelf	999141
---	--------

Beds

Bed in special length 190 cm	99964
------------------------------	-------

Bed with two footboards (all-round bed; not possible on beds with bed surround frame of leather)	99967	no surcharge
--	-------	--------------

Special-sized products for special combinations:

Pricing: recommended retail price of the special combination + 15% plus the recommended retail prices of all the required special-sized products (see above)

More special products are possible.

Please get in touch with your customer advisor.

ELUMO II

Wardrobes

Special heights:

Hinge-door	- Wood	0003	no surcharge
Hinge-door	- Mirror	00031	no surcharge

Special widths (not possible for doors with artificial leather or genuine leather application or on intermediate units):

for single-door unit	- Wood	0005
for single-door unit	- Mirror	00051
for twin-door unit	- Wood	0006
for twin-door unit	- Mirror	00061

When ordering extra fitted shelves and clothes rods

Size reduction surcharge per fitted shelf	9991
Size reduction surcharge per clothes rod	9992

Special depths (not possible on intermediate units with open compartment in artificial leather or genuine leather):

Surcharge per unit	0007
--------------------	------

When ordering extra fitted shelves

Size reduction surcharge per fitted shelf	9993
---	------

Intermediate unit

Depth reduced by 12 cm	
Depth reduced by 24 cm	

Side sloping:

Surcharge per unit without passepartout in the slope	9994
--	------

Surcharge per unit with passepartout in the slope	99916
---	-------

Rear sloping:

Surcharge per unit	99912
--------------------	-------

Ancillary units

Special heights (drawers not possible in special height):

Carcase	99902
Door	99903

Special widths (not possible with integrated niche lamps, on ancillary units with open compartment in artificial leather or genuine leather or on 80 cm wide consoles and chests; width reduction on 120 cm wide chests with open compartment: max. 40 cm):

Carcase	999120
Door	999130
Drawer	999140
Wall shelf (min. 36 cm wide)	999753

When ordering extra fitted shelves

Size reduction surcharge per fitted shelf	999141
---	--------

Beds

Bed in special length 190 cm	99964
------------------------------	-------

Upholstered headboard in special height	99965
---	-------

Special-sized products for special combinations:

Pricing: recommended retail price of the special combination + 15% plus the recommended retail prices of all the required special-sized products (see above)

More special products are possible.

Please get in touch with your customer advisor.

FENA

Wardrobes

Special heights:

Hinge-door	- Wood	0003	no surcharge
Hinge-door	- Mirror	00031	no surcharge

Special widths:

for single-door unit	- Wood	0005
for single-door unit	- Mirror	00051
for twin-door unit	- Wood	0006
for twin-door unit	- Mirror	00061

When ordering extra fitted shelves and clothes rods

Size reduction surcharge per fitted shelf	9991
Size reduction surcharge per clothes rod	9992

Special depths:

Surcharge per unit	0007
--------------------	-------------

When ordering extra fitted shelves

Size reduction surcharge per fitted shelf	9993
---	-------------

Side sloping:

Surcharge per unit	9994
--------------------	-------------

Rear sloping:

Surcharge per unit	99912
--------------------	--------------

Beds

Bed in special length 190 cm	99964	
Bed with two footboards (all-round bed)	99967	no surcharge

Special-sized products for special combinations:

Pricing: recommended retail price of the special combination + 15% plus the recommended retail prices of all the required special-sized products (see above)

More special products are possible.

Please get in touch with your customer advisor.

GENTIS

Wardrobes

Special heights:

Hinge-door	- Wood	0003	no surcharge
Hinge-door	- Mirror	00031	no surcharge

Special widths:

for single-door unit	- Wood	0005
for single-door unit	- Mirror	00051
for twin-door unit	- Wood	0006
for twin-door unit	- Mirror	00061

When ordering extra fitted shelves and clothes rods

Size reduction surcharge per fitted shelf	9991
Size reduction surcharge per clothes rod	9992

Special depths:

Surcharge per unit	0007
--------------------	-------------

When ordering extra fitted shelves

Size reduction surcharge per fitted shelf	9993
---	-------------

Side sloping:

Surcharge per unit	9994
--------------------	-------------

Rear sloping:

Surcharge per unit	99912
--------------------	--------------

Special-sized products for special combinations:

Pricing: recommended retail price of the special combination + 15% plus the recommended retail prices of all the required special-sized products (see above)

More special products are possible.

Please get in touch with your customer advisor.

LA VELA II

Wardrobes

Special heights:

Hinge-/folding-door wing	- Wood	0003	no surcharge
Hinge-/folding-door wing	- Mirror	00031	no surcharge

Special widths (not possible on high-gloss fronts):

for single-door unit	- Wood	0005
for single-door unit	- Mirror	00051
for twin-door unit	- Wood	0006
for twin-door unit	- Mirror	00061
for panorama unit	- Wood	00062
for panorama unit	- Mirror	00063

When ordering extra fitted shelves and clothes rods

Size reduction surcharge per fitted shelf	9991
Size reduction surcharge per clothes rod	9992

Special depths:

Surcharge per unit	0007
--------------------	------

When ordering extra fitted shelves

Size reduction surcharge per fitted shelf	9993
---	------

Intermediate unit

Depth reduced by 12 cm	00071012
Depth reduced by 24 cm	00071024

Side sloping:

Surcharge per unit without cornice in the slope	9994
Surcharge per unit with cornice in the slope	99916

Rear sloping:

Surcharge per unit	99912
--------------------	-------

Ancillary units

Special heights (drawers not possible in special height):

Carcase	99902
Door	99903
Cover panel	99900
Utility chest in drawer raster	99902

Profiled glass doors not possible in special height.

Special widths (the sides of veneer versions are not curved, straight rim; please state from which side the reduction should begin):

Carcase	999120
Door	999130
Drawer	999171
Cover panel	99925
Flap	999180
Wall shelf (min. 36 cm wide)	999753

When ordering extra fitted shelves

Size reduction surcharge per fitted shelf	999141
---	--------

Special depths (drawers not possible in special depth):

Carcase	99932
---------	-------

When ordering extra fitted shelves

Size reduction surcharge per fitted shelf	999341
---	--------

Beds

Headboard in special width without alteration

to inside bed size (max. 3.5 cm each side)	99961
--	-------

Headboard in special height	99965
-----------------------------	-------

Bed with two footboards up to 2 m length

(all-round bed; not possible for hovering beds)	99967	no surcharge
---	-------	--------------

Special-sized products for special combinations:

Pricing: recommended retail price of the special combination + 15% plus the recommended retail prices of all the required special-sized products (see above)

More special products are possible.

Please get in touch with your customer advisor.

LUNIS

Wardrobes

Special heights:

Hinge-door	- Wood	0003	no surcharge
Hinge-door	- Mirror	00031	no surcharge

Special widths:

for single-door unit	- Wood	0005
for single-door unit	- Mirror	00051
for twin-door unit	- Wood	0006
for twin-door unit	- Mirror	00061

When ordering extra fitted shelves and clothes rods

Size reduction surcharge per fitted shelf	9991
Size reduction surcharge per clothes rod	9992

Special depths:

Surcharge per unit	0007
When ordering extra fitted shelves	

Size reduction surcharge per fitted shelf	9993
---	------

Side sloping:

Surcharge per unit without cornice profile in the slope	9994
Surcharge per unit with cornice profile in the slope	99916

Side sloping is possible up to a minimum height of 88.0 cm.

Rear sloping:

Surcharge per unit	99912
--------------------	-------

Ancillary units

Special heights (drawers not possible in special height and not possible on high-gloss versions)

Carcase	99902
Door	99903
Chest of drawers in drawer raster	99902

Special widths (not possible on high-gloss versions):

Carcase	999120
Door	999130
Drawer	999170
Pedestal	99930
Headboard panel	99925

When ordering extra fitted shelves

Size reduction surcharge per fitted shelf	999141
---	--------

Special widths are not possible on panel carcase and on angled shelves (for headboard panels).

Special depths (drawers not possible in special depth):

Carcase	99932
---------	-------

When ordering extra fitted shelves

Size reduction surcharge per fitted shelf	999341
---	--------

Beds

Bed in special length 190 cm	99964
------------------------------	-------

Upholstered headboard in special height	99965
---	-------

Bed with two footboards (all-round bed)	99967
---	-------

Special width and height are not possible on the profiled wood/lacquer headboard.

Special-sized products for special combinations:

Pricing: recommended retail price of the special combination + 15% plus the recommended retail prices of all the required special-sized products (see above)

More special products are possible.

Please get in touch with your customer advisor.

METIS plus

Wardrobes

Special heights:

Hinge-/folding-door	- High-gloss	0003	no surcharge
Hinge-/folding-door	- Mirror	00031	no surcharge
Sliding-door	- High-gloss	0004	
Sliding-door	- Mirror	00041	

Special widths (not possible on hinge-/folding-doors):

Sliding-door	- High-gloss	00064
Sliding-door	- Mirror	00065

When ordering extra fitted shelves and clothes rods

Size reduction surcharge per fitted shelf	9991
Size reduction surcharge per clothes rod	9992

Width reductions of sliding-door wardrobes: **minimum widths**

2-door sliding-door wardrobe (all widths):
reducible down to min. 152.0 cm width
(please note the next smaller width!)

Note: If sliding-door wardrobes are required in a special width, the width of all the doors is reduced symmetrically.

Special widths are not possible on intermediate units and on hinge-/folding-door wardrobes

Special depths:

Surcharge per unit	0007
--------------------	-------------

When ordering extra fitted shelves

Size reduction surcharge per fitted shelf	9993
---	-------------

Intermediate units

Depth reduced by 12 cm
Depth reduced by 24 cm

Side sloping:

Surcharge per unit	9994
--------------------	-------------

Rear sloping:

Surcharge per unit	99912
--------------------	--------------

Other:

Twin-door sliding-door wardrobes are also available in reverse order (left door runs in front, right door behind). Please add an -S to the type no. in this case (e.g. **2421-S**)

no surcharge

Ancillary units

Special heights (drawers not possible in special height):

Carcase high-gloss	999021
Door high-gloss	999031
Chest of drawers in drawer raster	
Carcase high-gloss	999021

Beds

(only on beds in high-gloss version;
not possible on upholstered beds)

Headboard in special height (reduced in cm steps up to a max. 15 cm)	99965	
Bed in special length 190 cm	99964	
Bed in special width	99969	
Bed with two footboards (all-round bed; only possible for 200 cm length)	99967	Price deduction

Special sizes are not possible on upholstered beds.

Special-sized products for special combinations:

Pricing: recommended retail price of the special combination + 15% plus the recommended retail prices of all the required special-sized products (see above)

More special products are possible.

Please get in touch with your customer advisor.

MULTI-FORMA II

Special heights:

Hinge-/folding-door	- Wood/high-gloss	0003	no surcharge
Hinge-/folding-door	- Mirror	00031	no surcharge
Sliding-door	- Wood/high-gloss	0004	no surcharge
Sliding-door	- Mirror	00041	no surcharge

Special widths:

for single-door unit	- Wood/high-gloss	0005	no surcharge
for single-door unit	- Mirror	00051	no surcharge
for twin-door unit	- Wood/high-gloss	0006	no surcharge
for twin-door unit	- Mirror	00061	no surcharge
for panorama unit	- Wood/high-gloss	00062	no surcharge
for panorama unit	- Mirror	00063	no surcharge
Sliding-door	- Wood/high-gloss	00064	no surcharge
Sliding-door	- Mirror	00065	no surcharge

Special widths are not possible on profiled hinge-door end units, on intermediate units and on hinge-/folding-door wardrobes with doors with high-gloss fronts in design A, G, J and F.

When ordering extra fitted shelves and clothes rods			
Size reduction per fitted shelf	9991	no surcharge	
Size reduction per clothes rod	9992	no surcharge	

Width reductions of sliding-door wardrobes: **minimum widths**

2-door sliding-door wardrobe (all widths):
reducible down to min. 152.0 cm width
(please note the next smaller width!)
3-door sliding-door wardrobe (width 242 cm):
reducible down to min. 227.0 cm width
3-door sliding-door wardrobe (widths 272, 302 and 332 cm):
reducible down to min. 243.0 cm width
(please note the next smaller width!)
4-door sliding-door wardrobe (all widths):
reducible down to min. 302.0 cm width
(please note the next smaller width!)

Note: If sliding-door wardrobes are required in a special width, the width of all the doors is reduced symmetrically.

Special depths:

per unit	0007	no surcharge
----------	-------------	--------------

When ordering extra fitted shelves		
Size reduction per fitted shelf	9993	no surcharge

Intermediate units (not possible on intermediate units 1, 10, 4 and 11)
Depth reduced by 12 cm
Depth reduced by 24 cm

Side sloping:

Surcharge per unit without cornice profile in the slope		
Design A	99941	
Design A plus	99946	
Design G	99943	
Design G plus	99947	
Design L	99944	
Design F	99942	
Design F plus	99948	

Surcharge per unit with cornice profile in the slope		
Design A	999161	
Design A plus	999166	
Design G	999163	
Design G plus	999167	
Design L	999164	
Design F	999162	
Design F plus	999168	

Carcase room system	99949
---------------------	--------------

Side sloping of profiled hinge-door end units and of doors in Design J are not possible.

Rear sloping:

Surcharge per unit	99912
--------------------	--------------

Rear sloping of profiled hinge-door end units on request.

Other:

Horizontal passepartout in high-gloss version only available in combination with a vertical passepartout.

Twin-door sliding-door wardrobes are also available in reverse order (left door runs in front, right door behind).

Please add an -S to the type no. in this case (e.g. **A55162-S**)

no surcharge

Hinge-door units in widths of 42/40, 52/50, 72/70, 82/80 and 102/100 cm and in heights of 229.6 and 268.0 cm can also be fitted with **rod handle locks** against a surcharge (exception: rod handle locks not possible on hinge-doors in Design J, F and F plus).

Surcharge for rod handle lock per hinge-door:

for single-door hinge-door unit,	
left hinge	901
for single-door hinge-door unit,	
right hinge	902
for twin-door hinge-door unit	903

Bottom end slat:

If hinge-door units are fitted with rod handle locks, a bottom end slat must be planned. In this case, the total height of an optional wardrobe interior fitting is then increased by 3.2 cm.

for wardrobe inside width 48 cm	79243
for wardrobe inside width 58 cm	79242
for wardrobe inside width 68 cm	79248
for wardrobe inside width 78 cm	79244
for wardrobe inside width 98 cm	79246

More special products are possible.

Please get in touch with your customer advisor.

MULTI-VARIS

Ancillary units

Special heights (drawers not possible in special height):

Carcase wood/lacquer	99902
Carcase high-gloss	999021
Door wood/lacquer	99903
Door high-gloss	999031

More special products are possible.

Please get in touch with your customer advisor.

SERA

No special-sized products are possible in the SERA range.

Special-sized products

Special articles

Wardrobe doors are also available as separate units and are charged as follows:

a) For 1 hinge-door/folding-door wing: 50% of the concerning 1-door hinge-door extension unit

b) For 1 sliding-door including mechanism: 35% of the twin-door sliding-door wardrobe

For door superstructures, type **100** (max. 98 cm wide, only for assembly between wardrobes):
100% of twin-door hinge-door extension unit

Panels for side and top covering of fitted wardrobes (not possible for high-gloss versions;
support construction and fitting materials must be acquired on site).

a) for veneered/lacquered versions (max. 268.0 cm long, max. 61.6 cm wide, 2.0 cm thick)

Basis charge per order: **9901**

+ price per sq. m. - lacquer **990**

+ price per sq. m. - veneer **990**

Veneer match with fronts can not be guaranteed.

Edge veneer for veneered/lacquered versions per m. length **9902**

Wardrobe doors can also be fitted with **165° hinges** against a surcharge
(only possible on plain, straight hinge-doors).
Please mark the doors clearly in the order!

Surcharge for 165° hinges per hinge-door: **180**

High-gloss care set

Polish, polishing sponge and polishing cloth (incl. instructions)
for protecting and maintaining the high-gloss surfaces **36**

Special colours

All the hülsta lacquer colours are possible for nearly all the hülsta ranges.
Availability and prices on request.

Wall composition / assembly instruction

Important notes:

The composition of walls must be ascertained before concluding a contract and be checked by a qualified fitter before assembly takes place.







Assembly may only be carried out by a qualified fitter under careful observation of the assembly instructions.

The plastic Rawl plugs with the type name SX 8 x 65 from the Fischer Company supplied by hülsta as a standard set are only suitable for concrete \geq C12/15, if the wall composition and compression strength corresponds to the table below. Under no circumstances must a unit be assembled on light masonry.

Furthermore, we provide a mounting set with assembly mortar from the Fischer Company for the types of walls listed below (see assembly mortar set below). Again, assembly must be carried out by a qualified fitter under careful observation of the wall composition and assembly instruction. The compression strength levels stated below must be met under all circumstances.

Materials table

with a description of which sets are to be used with the following types of walls:

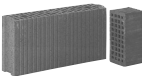
Standard set (SX 8 x 65)	Assembly mortar set only suitable for the materials stated below!	
Concrete C12/15 Compression strength \geq 15 N/mm ² 	 Building bricks Mz 12 Compression strength \geq 12 N/mm ²	 Solid blocks of light concrete V2 Compression strength \geq 2 N/mm ²
	 Limestone blocks KS 12 Compression strength \geq 12 N/mm ²	 Perforated blocks of light concrete Hbl 2 Compression strength \geq 2 N/mm ²
	 Perforated sand lime bricks KSL12 Compression strength \geq 12 N/mm ²	 Aerated concrete PP2 Compression strength \geq 2 N/mm ²
	 Vertically perforated bricks HLz 12 Compression strength \geq 12 N/mm ² Bulk density \geq 1.0 kg/dm ³	

A different and more suitable type of mounting must be chosen by a qualified fitter in all other cases. hülsta cannot accept any responsibility for the choice of any other types of mounting!

Please note that if the units are not mounted properly on the wall, there is a risk of the units falling down or tipping over – especially when alternative mounting materials acquired on site have been used.

Generally speaking, you as a dealer/qualified fitter are responsible for the correct wall mounting of the units.



Mounting sets

Labelling in type list drawings / assembly notes for wall units

The majority of units have two wall mounting points (= number of support boards), if these are to be fitted as wall units. This is not explicitly mentioned in the type list. If a different number of wall mounting points (= support boards) is required, this is marked in the drawings in the type list with numbers in black boxes. Every support board requires four mounting screws.

3 = 3 support boards

4 = 4 support boards, etc.

One **assembly mortar set** is sufficient for up to a maximum of 3 support boards or 4 wall side-panels.

Important note: Depending on the composition of the wall (see wall types illustrated above), assembly must be carried out using the special assembly mortar set and a standard trade mastic tool which are the basic essentials for safe and clean workmanship.

Standard set

The standard set consists of 4 plastic Rawl plugs (SX 8 x 65) and 4 mounting screws and is sufficient for 1 support board. The standard sets are included in the packet of fittings to match the number of support boards.

Assembly mortar set for up to a maximum of 3 support boards consisting of:

- 9x injection retaining sleeve
- 9x screw-in sleeve
- 1x injection cartridge
- 2x static mixer
- 1x assembly instructions

Please use the mounting screws from the standard set (supplied free of charge).

Example of order:

- Add up number of support boards for all existing unit types
 - Divide the sum by "3"
 - Round up the result to a full number
- = Number of assembly mortar sets required

M2