



# LA VELA II

LA VELA II is a timelessly modern and gracefully light bedroom range which enables individual extendable and solitary suites with some most expressive models. LA VELA II provides a lot of innovative functions to meet the needs of the young and young-at-heart regarding comfort and homeliness.

## Wardrobes

Height reductions at intervals of 1.0 cm without surcharge (not possible on combined folding-door wardrobes with integrated functional TV unit)!

- Hinge- and folding-door wardrobes and combined folding-door wardrobes with integrated functional TV unit according to the endless assembly principle
- Hinge-door and folding-door wardrobes and combined folding-door wardrobes with integrated functional TV unit can be combined at will
  - With plain doors (with optional mirror and in colour touch)
  - Optionally
    - with passepartout
    - with top LED lamp (12 V, 2.4 W)
    - with all round passepartout and top LED lamp (12 V, 2.4 W)
  - Corner wardrobe 45° (hinge-door)
  - Intermediate unit with vertical sliding-door for optical alternation
  - Extra-wide panorama units (160/200 cm) without centre partition
  - Integrated, swing-out clothes rod in wardrobe centre partition
  - Functional and high-quality **wardrobe interior fittings** (see separate chapter "Wardrobe interior fittings")

## Beds

- Beds-on-legs in two heights, seven widths and four lengths
- Compact beds, with optional linen box, and hovering beds in seven widths and four lengths
- Comprehensive bed accessories: different bed lamps, add-on footboard, mobile linen box

In combination with the hülsta Sleeping System, the beds guarantee highest sleeping comfort. With its high-grade quality spring base frames and mattresses, the hülsta Sleeping System provides the perfect prerequisites for relaxing sleep (see separate chapter "SLEEPING SYSTEMS").

## Ancillary units

- Consoles in two heights and two widths and corner consoles
- Chests in two heights and three widths, profiled end chests with glass door, corner chests, utility chest, chest of drawers and high chests
- Utility/dressing tables
- Wall units with flap or door and open wall units
- Wall shelves, mirrors, accessories

## Handle version

Hinge-/folding-door wardrobe, ancillary units

With the LA VELA II hinge- and folding-door wardrobes and for the ancillary units you can choose between the high-gloss chrome and matt chrome handle versions (for wardrobes: aluminium colour). The required handle version must be stated in the order. If no handle version is stated in the order, high-gloss chrome handles (for wardrobes: handle 026) are delivered ex-works.

## Quality features

- All wardrobe doors with brake mechanism
- Wardrobe doors with handle and spring hinges
- Lamps GS-tested, VDE tested
- Extra-wide fitted wardrobe shelves (160/200 cm) of triple glued coreboard
- All metal hinges
- Innovative door opening bracket (resting on wardrobe carcass)
- Optically unobtrusive 2.5 mm drilled holes for wardrobes
- Centre partition and side sections of wardrobes with special plinth adjustment
- **hülsta-SoftFlow**: Drawers of intermediate units and ancillary units on hidden bearings incl. auto pull-in feature with brake
- **hülsta-MagicClose**: All wooden hinge-doors with door hinge brake

**Handle 026**  
standard handle,  
high-gloss chrome

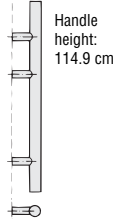

**Handle 013**  
aluminium coloured

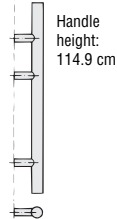

**Important notes:** Generally speaking, you as a dealer/qualified fitter are responsible for the correct wall mounting of the units. That is why wall mounting should only be carried out by properly trained and qualified fitters. hülsta supplies materials for mounting units on walls for nearly all the units and which should be used for safety and for constructional reasons. The assembly materials supplied by hülsta (plugs, screws) are only suitable for fitting components on to concrete in firmness class (C12/15). For other materials (please see separate materials table in the wall composition chapter) we provide you with an assembly mortar set as an extra order. Please note that this assembly mortar set is also only suitable for the materials listed in the materials table. If walls are made up of other materials (e.g. plastered or lighter wall materials), one should use another method of mounting better suited to the load on site. Please note that if the units are not mounted properly on the wall, there is a risk of the units falling down or tipping over – especially when alternative mounting materials acquired on site have been used. For the reasons stated above it is absolutely essential to enquire about the composition of any walls before signing any contracts.

Top headboard section of beds also in 3 different leather colours (see pages 97-98)

## List of versions System colours

Model no.	Version	Price group
730	White lacquer	I
731	Structured beech	I
732	Walnut	II

Wardrobe doors and certain models are also available with colour touches (specially marked; see right)!

### Changing versions

With LA VELA II you can choose the carcass and the front in a different version. In this case please state the model number for the front and the carcass separately in the order. When versions from different price groups are exchanged, the higher price group is always charged.

## List of versions Colour touches

Model no.	Version
733	<b>High-gloss white:</b> for wardrobe doors <b>White lacquer:</b> for top headboard section of beds, for top panels of consoles, for carcass of wall units and for box drawers <b>Rear-lacquered glass white:</b> for fronts of wall units
734	<b>High-gloss sand:</b> for wardrobe doors <b>Sand lacquer:</b> for top headboard section of beds, for top panels of consoles, for carcass of wall units and for box drawers <b>Rear-lacquered glass sand:</b> for fronts of wall units
	Certain models which are available with colour touches are specially marked!

# Special combinations with bed-on-legs in surface height 1

Please also note the mattresses and base frames in the separate "SLEEPING SYSTEMS" chapter!

Special combinations consisting of a bed unit (bed-on-legs in surface height 1 and two drawer consoles) and one hinge- or folding-door wardrobe.

The price of an entire special combination (bed unit and wardrobe) can be found in the grey shaded boxes!

**Bed unit:**

consisting of a bed-on-legs in surface height 1 and two drawer consoles (with top cover panel) with chrome surface handles; handles possible in matt chrome (without surcharge)

**Hinge- or folding-door wardrobe:**

wardrobe with hinge- or folding-doors, optional in colour touch (without surcharge) or with mirror (against surcharge), with chrome surface handles; handles possible in aluminium colour (without surcharge). Height reductions of wardrobes at intervals of 1.0 cm without surcharge.

Please state all surface versions clearly in the order!

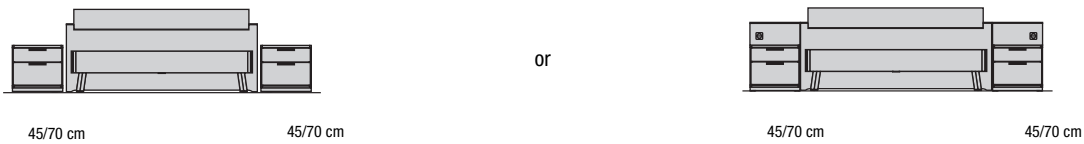

**Important:** Choose a bed-on-legs in surface height 1 (all bed sizes possible – please state type number; see page 97), two consoles (all types of console possible – please state type number; see page 100) as well as one of the wardrobes listed below.

		4-door hinge- or folding-door wardrobe 202 cm wide				5-door hinge- or folding-door wardrobe (middle unit always with hinge-door, hinges right) 252 cm wide				6-door hinge- or folding-door wardrobe 302 cm wide			
		Information on the energy class: see below!				Information on the energy class: see below!				Information on the energy class: see below!			
		with hinge-doors	with folding-doors	Surcharge for passe-partout frame	Surcharge for top LED lamp 1 lamp per unit	with hinge-doors	with folding-doors	Surcharge for passe-partout frame	Surcharge for top LED lamp 1 lamp per unit	with hinge-doors	with folding-doors	Surcharge for passe-partout frame	Surcharge for top LED lamp 1 lamp per unit
Price gr. I II		A 8406	A 8407	301	0383	A 8416	A 8417	303	0385	A 8436	A 8437	304	0385

## Surcharge for bed-on-legs in surface height 2

<p><b>Bed-on-legs in surface height 2:</b> The special combination is supplied with a standard bed-on-legs in surface height 1. It is also optionally available with a bed-on-legs in surface height 2 (against surcharge).</p> <p>Please state clearly in the order!</p>	Surcharge for bed-on-legs in surface height 2
	3023

## Additional fittings

<p><b>Top LED lamp</b></p> <p>Surcharge for each additional lamp type 3690 =</p> <p>This luminaire contains built in LED lamps of the energy classes A++ to A. The lamps cannot be changed in the luminaire. 12 V; 2,4 W</p>	<p><b>Surcharge for mirror</b></p> <p>Each wardrobe door can be optionally fitted with a mirror (vertical facette) for which a surcharge is made.</p> <p><b>Mirror surcharge per hinge-door:</b></p>
--	--

# Special combinations with compact bed

Please also note the mattresses and base frames in the separate "SLEEPING SYSTEMS" chapter!

List of versions: see page 88

Special combinations consisting of a bed unit (compact bed and two drawer consoles) and one hinge- or folding-door wardrobe.

The price of an entire special combination (bed unit and wardrobe) can be found in the grey shaded boxes!

**Bed unit:**

consisting of a compact bed and two drawer consoles (with top cover panel) with chrome surface handles; handles possible in matt chrome (without surcharge)

**Hinge- or folding-door wardrobe:**

wardrobe with hinge- or folding-doors, optional in colour touch (without surcharge) or with mirror (against surcharge), with chrome surface handles; handles possible in aluminium colour (without surcharge). Height reductions of wardrobes at intervals of 1.0 cm without surcharge.

Please state all surface versions clearly in the order!

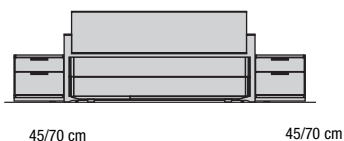

or

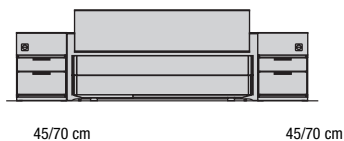

**Important:** Choose a compact bed (all bed sizes possible – please state type number; see page 98), two consoles (all types of console possible – please state type number; see page 100) as well as one of the wardrobes listed below.

	4-door hinge- or folding-door wardrobe 202 cm wide				5-door hinge- or folding-door wardrobe (middle unit always with hinge-door, hinges right) 252 cm wide				6-door hinge- or folding-door wardrobe 302 cm wide			
	Information on the energy class: see below!				Information on the energy class: see below!				Information on the energy class: see below!			
	with hinge-doors	with folding-doors	Surcharge for passe-partout frame	Surcharge for top LED lamp 1 lamp per unit	with hinge-doors	with folding-doors	Surcharge for passe-partout frame	Surcharge for top LED lamp 1 lamp per unit	with hinge-doors	with folding-doors	Surcharge for passe-partout frame	Surcharge for top LED lamp 1 lamp per unit
Price gr. I II	A 8506	A 8507	301	0383	A 8516	A 8517	303	0385	A 8536	A 8537	304	0385

## Surcharge for compact bed with linen box

**Compact bed with linen box:**

The special combination is supplied with a standard compact bed without linen box. It is also optionally available with a compact bed with linen box and hülstafflex comfort Lift base frame (against surcharge).

Please state clearly in the order!

Surcharge for compact bed with linen box and hülstafflex comfort Lift base frame

3024

## Additional fittings

**Top LED lamp**

Surcharge for each additional lamp type 3690 =

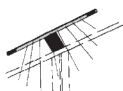

This luminaire contains built in LED lamps of the energy classes A++ to A. The lamps cannot be changed in the luminaire. 12 V; 2,4 W

**Surcharge for mirror**

Each wardrobe door can be optionally fitted with a mirror (vertical facette) for which a surcharge is made.



Mirror surcharge per hinge-door:

## Notes on planning hinge- and folding-door wardrobes and combined folding-door wardrobes with integrated functional TV unit according to the endless assembly principle

consisting of basic and extension units. Due to the various element widths one can create many total wardrobe widths. In this way the available floor space can be exploited to the full. For each wardrobe combination, the first element on the left is considered to be the basic unit, incorporating both outer side-sections. One can only include one basic unit in each combination. When adding on extension units, the right-hand side-section of the basic unit is employed as the end side-section of the complete combination. In the case of single-door hinge-door units as well as folding-door wardrobes one can choose between left- and right-hand hinges. The graphics shown below give you an excerpt of our wardrobe assortment. For optical variations, we suggest using an intermediate unit for creating some alternatives.

Standard interior fittings per unit: 2 fitted shelves, 1 clothes rod.  
All interior surfaces are in white lacquer.

## Examples of wardrobes

### Hinge-door wardrobe with integrated pull-out clothes rods

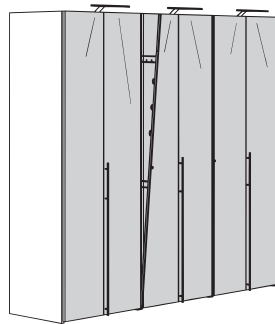
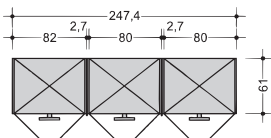

- Hinge-door wardrobes can be combined with folding-door wardrobes, combined folding-door wardrobes and intermediate units
- Front mirrors (at surcharge) and fronts in colour touch (no surcharge) are available
- Centre partition (4.7 cm thick), with integrated, swing-out clothes rod
- Unit outside widths: 42, 52, 82, 102 cm (basic units)
- Unit inside widths: 40, 50, 80, 100 cm (extension units)
- Outside depth: 61.0 cm
- Inside depth: 56 cm
- Door opening angle: approx. 110°

For calculating the overall width when fitting the passepartout frame, please note the passepartout frame protrusion of 3.1 cm left and right! The total width of the wardrobe is also increased by 2.7 cm when a swing-out clothes rod is included.

### Combined folding-door wardrobe with integrated functional TV unit

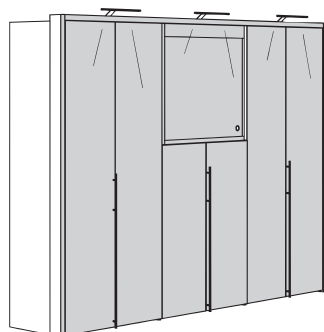
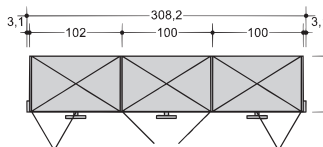

- Description of hinge-/folding-door wardrobes see above
- Combined folding-door wardrobes with integrated functional TV unit: left type (L): left folding-door wardrobe, doors with left hinge; right functional TV unit: top TV compartment with horizontal sliding-door (sliding-door opens to left), bottom 2 hinge-doors; right type (R): right folding-door wardrobe; left functional TV unit (sliding-door opens to right) and 2 hinge-doors
- Unit outside width: 202 cm
- Outside depth: 61.0 cm

For calculating the overall width when fitting the passepartout frame, please note the passepartout frame protrusion of 3.1 cm left and right! The total width of the wardrobe is also increased by 2.7 cm when a swing-out clothes rod is included.

## Dims.

	without passepartout	with passepartout
Heights incl. plinth;	229.6 cm	233.9 cm
Heights with top LED lamp + 9.3 cm	<b>Height reductions at intervals of 1.0 cm without surcharge</b>	
Depth	<b>61.0 cm</b>	
Depth with top LED lamp	<b>69.0 cm</b>	
Widths	see pages 90-94	

### Hinge-/folding-door wardrobe with integrated intermediate unit

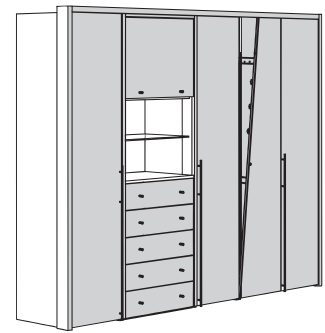
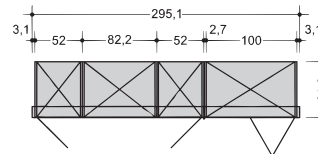

- Folding-door wardrobes can be combined with hinge-door wardrobes, combined folding-door wardrobes and intermediate units
- Front mirrors (at surcharge) and fronts in colour touch (no surcharge) are available
- Centre partition (4.7 cm thick), with integrated, swing-out clothes rod
- Extra-wide panorama units in 160/162 and 200/202 cm width without centre partition
- Intermediate unit: top open compartments, 1 fitted wooden shelf (not adjustable), 1 fitted glass shelf, vertical sliding-door with wooden frame; bottom five drawers;
- Note: only suitable as intermediate unit!
- Unit outside widths: 82, 102, 162, 202 cm (basic units)
- Unit inside widths: 80, 100, 160, 200 cm (extension units)
- Unit inside widths: 82.2 cm (intermediate unit)
- Outside depth: 61.0 cm
- Inside depth: 56 cm

For calculating the overall width when fitting the passepartout frame, please note the passepartout frame protrusion of 3.1 cm left and right! The total width of the wardrobe is also increased by 2.7 cm when a swing-out clothes rod is included.

## Lamps (GS-tested)



All hinge- and folding-door wardrobes and combined folding-door wardrobes with integrated functional TV unit are available with optional top LED lamps. The top LED lamp (12 V, 2.4 W) is fitted above each unit – 1-door or 2-door (exception panorama unit: two top LED lamps). If required, a top LED lamp can be fitted centrally above each door. It is also possible to remove lamps with a price reduction.

**Please include a base sketch with each order.**

Switching is done by an external footswitch. A remote control unit is also available as an alternative, which is charged extra. The remote control unit incorporates one transmitter and one receiver which operate all the LED lamps. Extra transmitters are available against a surcharge. The footswitch is omitted when the remote control unit is employed.

Please note: When fitting top LED lamps, there must be a distance of at least 2.0 cm to the ceiling.

### Remote control unit

**Surcharge for remote control unit**  
(transmitter + receiver) type

**Surcharge for extra transmitter type**

**Surcharge for extra receiver type**



1601 =

1602 =

1603 =

### Top LED lamp

**Surcharge for each additional lamp type**

**Price reduction for one lamp type**

(if not required on panorama unit)



3690 =

3680 =





This luminaire contains built-in LED lamps of the energy classes A++ to A. The lamps cannot be changed in the luminaire. 12 V; 2.4 W

# Hinge-door wardrobes

For each project please remember to leave a 2.0 cm gap to the ceiling and at the side for assembly!

Please state handle version!

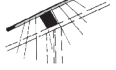
List of versions: see page 88

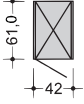
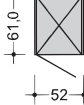
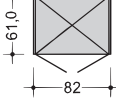
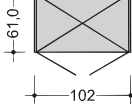
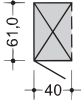
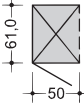
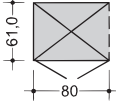
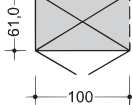
<p><b>Height: 229.6 cm</b> (with passepartout 233.9 cm; with top LED lamp 238.9 cm), height reductions at intervals of 1.0 cm without surcharge.  <b>Width: see table</b> (with passepartout + 3.1 cm each side)  <b>Depth: 61.0 cm</b> (with top LED lamp 69.0 cm)</p> <p>Interior fittings per unit: 2 fitted shelves, 1 clothes rod; all interior fittings are in a standard <b>white lacquer</b> version.</p> <p>Hinge-doors with chrome handles; wardrobe doors with optional mirror (at surcharge) or in colour touch (no surcharge).</p> <p>The surcharge for the passepartout frame of the basic units includes the left- and right-hand vertical frame as well as the horizontal frame, the surcharge for the extension units only includes the horizontal frame. When adding on extension units, the right-hand frame of the passepartout of the basic unit is used as the end unit of the complete combination.</p> <p><b>The passepartout unit is full-length up to 302 cm width.</b></p>		<p><b>Surcharge for passepartout</b></p> 	<p><b>Surcharge for top LED lamp</b></p> <p>1 lamp per unit</p> <p>Information on the energy class: see below!</p> 	<p><b>Colour touch</b></p> <p>Each wardrobe door can be fitted with an optional colour touch (high-gloss white or high-gloss sand; no surcharge).</p> 	<p><b>Surcharge for mirror</b></p> <p>Each wardrobe door can be fitted with an optional mirror (vertical facet), for which is surcharge is made.</p> 
<p><b>Basic units</b> with 2 outer side sections (each 2 cm thick)          For each wardrobe combination, the first element on the left is considered to be the basic unit, incorporating both outer side-sections. One can only include one basic unit in each combination. When adding on extension units, the right-hand side-section of the basic unit is employed as the end side-section of the complete combination.</p>	<p>Price group</p>	<p>Please also note the functional and high-quality <b>wardrobe interior fittings</b> as well as the special articles and possible <b>specialized products</b> in the separate chapters on "Wardrobe interior fittings" and "Special products".</p>			
 <p>Single door unit, left or right, 42 cm wide</p>	<p>I II</p>	<p>A 02011 L A 02012 R</p>	<p>341</p>	<p>380</p>	
 <p>Single door unit, left or right, 52 cm wide</p>	<p>I II</p>	<p>A 2011 L A 2012 R</p>	<p>342</p>	<p>380</p>	
 <p>Twin door unit, 82 cm wide</p>	<p>I II</p>	<p>A 0202</p>	<p>343</p>	<p>380</p>	
 <p>Twin door unit, 102 cm wide</p>	<p>I II</p>	<p>A 202</p>	<p>344</p>	<p>380</p>	
<p><b>Extension units</b> with 1 centre partition (2 cm thick)</p>					
 <p>Single door unit, left or right, 40 cm wide</p>	<p>I II</p>	<p>A 00011 L A 00012 R</p>	<p>346</p>	<p>382</p>	<p>no surcharge</p>
 <p>Single door unit, left or right, 50 cm wide</p>	<p>I II</p>	<p>A 0011 L A 0012 R</p>	<p>347</p>	<p>382</p>	<p><b>Colour touch!</b> Please state the colour touch version!</p>
 <p>Twin door unit, 80 cm wide</p>	<p>I II</p>	<p>A 0002</p>	<p>348</p>	<p>382</p>	
 <p>Twin door unit, 100 cm wide</p>	<p>I II</p>	<p>A 002</p>	<p>349</p>	<p>382</p>	<p><b>Surcharge for mirror per hinge-door:</b></p>

## Additional fittings for lamps

Please see also the information on page 89!





<p><b>Surcharge for remote control unit</b> (transmitter + receiver) type <b>1601 =</b></p> <p><b>Surcharge for extra transmitter type</b> <b>1602 =</b></p> <p><b>Surcharge for extra receiver type</b> <b>1603 =</b></p>	<p><b>Top LED lamp</b></p> <p><b>Surcharge for each additional lamp type 3690 =</b></p> <p>This luminaire contains built-in LED lamps of the energy classes A++ to A. The lamps cannot be changed in the luminaire. 12 V; 2.4 W</p> 
--	---

# Folding-door wardrobes

For each project please remember to leave a 2.0 cm gap to the ceiling and at the side for assembly!

Please state handle version!

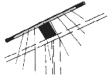
# LA VELA II

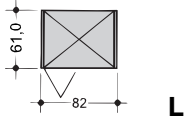
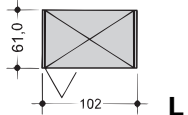
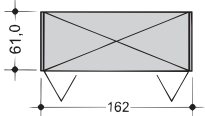
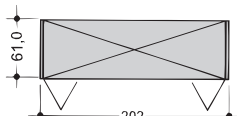
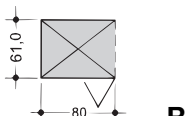
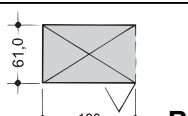
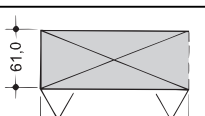
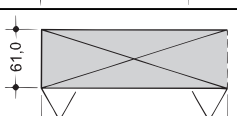
<p><b>Height: 229.6 cm</b> (with passepartout 233.9 cm; with top LED lamp 238.9 cm), height reductions at intervals of 1.0 cm without surcharge.</p> <p><b>Width: see table</b> (with passepartout + 3.1 cm each side)</p> <p><b>Depth: 61.0 cm</b> (with top LED lamp 69.0 cm)</p> <p>Interior fittings per unit: 2 fitted shelves, 1 clothes rod; all interior fittings are in a standard <b>white lacquer</b> version.</p> <p>Folding-doors with chrome handles; wardrobe doors with optional mirror (at surcharge) or in colour touch (no surcharge).</p> <p>The surcharge for the passepartout frame of the basic units includes the left- and right-hand vertical frame as well as the horizontal frame, the surcharge for the extension units only includes the horizontal frame. When adding on extension units, the right-hand frame of the passepartout of the basic unit is used as the end unit of the complete combination.</p> <p><b>The passepartout unit is full-length up to 302 cm width.</b></p>		<p><b>Surcharge for passepartout</b></p> 	<p><b>Surcharge for top LED lamp</b></p> <p>1 lamp per unit</p> <p>Information on the energy class: see below!</p> 	<p><b>Colour touch</b></p> <p>Each wardrobe door can be fitted with an optional colour touch (high-gloss white or high-gloss sand; no surcharge).</p> 	<p><b>Surcharge for mirror</b></p> <p>Each wardrobe door can be fitted with an optional mirror (vertical facet), for which is surcharge is made.</p> 	
<p><b>Basic units</b> with 2 outer side sections (each 2 cm thick)</p> <p>For each wardrobe combination, the first element on the left is considered to be the basic unit, incorporating both outer side-sections. One can only include one basic unit in each combination. When adding on extension units, the right-hand side-section of the basic unit is employed as the end side-section of the complete combination.</p>	<p>Price group</p>	<p>Please also note the functional and high-quality <b>wardrobe interior fittings</b> as well as the special articles and possible <b>specialized products</b> in the separate chapters on "Wardrobe interior fittings" and "Special products".</p>				
 <p>Twin-door unit, left or right, 82 cm wide</p>	<p>I II</p>	<p>A 2221 L A 2222 R</p>	<p>350</p>	<p>380</p>	<p>Please mark exactly in the front sketch or state in the order (from the left) which folding-door wings are to be fitted in which colour touch (optionally high-gloss white or high-gloss sand).</p> <p>Please mark exactly in the front sketch or state in the order (from the left) which folding-door wings are to be fitted with a mirror.</p> <p><b>no surcharge</b></p> <p><b>Surcharge for mirror per folding-door wing:</b></p>	
 <p>Twin-door unit, left or right, 102 cm wide</p>	<p>I II</p>	<p>A 2321 L A 2322 R</p>	<p>351</p>	<p>380</p>		
 <p>Panorama unit 4-door, 162 cm wide - without centre partition -</p>	<p>I II</p>	<p>A 2420</p>	<p>352</p>	<p>381 2 lamps</p>		
 <p>Panorama unit 4-door, 202 cm wide - without centre partition -</p>	<p>I II</p>	<p>A 2520</p>	<p>353</p>	<p>381 2 lamps</p>		
<p><b>Extension units</b> with 1 centre partition (2 cm thick)</p>						
 <p>Twin-door unit, left or right, 80 cm wide</p>	<p>I II</p>	<p>A 0221 L A 0222 R</p>	<p>355</p>	<p>382</p>		
 <p>Twin-door unit, left or right, 100 cm wide</p>	<p>I II</p>	<p>A 0321 L A 0322 R</p>	<p>356</p>	<p>382</p>		
 <p>Panorama unit 4-door, 160 cm wide - without centre partition -</p>	<p>I II</p>	<p>A 0420</p>	<p>357</p>	<p>383 2 lamps</p>		
 <p>Panorama unit 4-door, 200 cm wide - without centre partition -</p>	<p>I II</p>	<p>A 0520</p>	<p>358</p>	<p>383 2 lamps</p>		

## Additional fittings for lamps





Please see also the information on page 89!

<p><b>Surcharge for remote control unit</b> (transmitter + receiver) type <b>1601 =</b></p>	<p><b>Top LED lamp</b></p> <p>Surcharge for each additional lamp type <b>3690 =</b></p>
<p><b>Surcharge for extra transmitter type</b> <b>1602 =</b></p>	<p><b>Price reduction for one lamp</b> (if not required on panorama unit) type <b>3680 =</b></p>
<p><b>Surcharge for extra receiver type</b> <b>1603 =</b></p>	<p>This luminaire contains built-in LED lamps of the energy classes A++ to A. The lamps cannot be changed in the luminaire. 12 V; 2.4 W</p>

For each project please remember to leave a 2.0 cm gap to the ceiling and at the side for assembly!

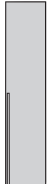
# Hinge-door corner wardrobes 45° – Basic and extension units

List of versions: see page 88

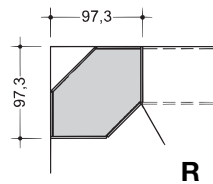
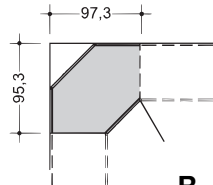



<p>Height: 229.6 cm (with passepartout 233.9 cm; with top LED lamp 238.9 cm), height reductions at intervals of 1.0 cm without surcharge.                      Width: see table (with passepartout + 3.1 cm each side)                      Depth: 61.0 cm (with top LED lamp 69.0 cm)</p> <p>Interior fittings per unit: see below; all interior fittings are in a standard <b>white lacquer</b> version.</p> <p>Hinge-doors with chrome handles; wardrobe doors with optional mirror (at surcharge) or in colour touch (no surcharge).</p> <p>The surcharge for the passepartout frame of the extension units only includes the horizontal frame. When adding on extension units, the right-hand frame of the passepartout of the basic unit is used as the end unit of the complete combination.</p> <p><b>The passepartout unit is full-length up to 302 cm width. If a hinge-door corner wardrobe extension unit is included in a wardrobe combination as the last unit on the right, the passepartout is not possible.</b></p>		<p>Surcharge for passepartout</p> 	<p>Surcharge for top LED lamp</p> <p>1 lamp per unit</p> <p>Information on the energy class: see page 89 below!</p> 	<p>Colour touch</p> <p>Each wardrobe door can be fitted with an optional colour touch (high-gloss white or high-gloss sand; no surcharge).</p> 	<p>Surcharge for mirror</p> <p>Each wardrobe door can be fitted with an optional mirror (vertical facet), for which is surcharge is made.</p> 
<p><b>Basic units</b> with 2 outer side sections (each 2 cm thick)</p> <p>For each wardrobe combination, the first element on the left is considered to be the basic unit, incorporating both outer side-sections. One can only include one basic unit in each combination. When adding on extension units, the right-hand side-section of the basic unit is employed as the end side-section of the complete combination.</p>	<p>Price group</p>	<p>Please also note the functional and high-quality <b>wardrobe interior fittings</b> as well as the special articles and possible <b>special-sized products</b> in the separate chapters on "Wardrobe interior fittings" and "Special products".</p>			
 <p><b>Hinge-door corner wardrobe 45°</b>                      Interior fittings:                      1 fitted shelf without clothes rod                      1 fitted shelf with clothes rod</p> <p>For production we require the details of series of assembly from left to right.</p> <p><b>R</b>                      L/R = door hinge left/right</p>	<p>I II</p>	<p>A 22191 L A 22192 R</p>	<p>365</p>	<p>380</p>	<p>Please mark exactly in the front sketch or state in the order (from the left) which hinge-doors are to be fitted in which colour touch (optionally high-gloss white or high-gloss sand).</p> <p>Please mark exactly in the front sketch or state in the order (from the left) which hinge-doors are to be fitted with a mirror.</p>
<p><b>Extension units</b> with 1 centre partition (2 cm thick)</p>					
 <p><b>Hinge-door corner wardrobe 45°</b>                      Interior fittings:                      1 fitted shelf without clothes rod                      1 fitted shelf with clothes rod</p> <p>For production we require the details of series of assembly from left to right.</p> <p><b>R</b>                      L/R = door hinge left/right</p>	<p>I II</p>	<p>A 20191 L A 20192 R</p>	<p>A passepartout section cannot be fitted if the hinge-door corner wardrobe extension unit is included as the last unit (= end of wardrobe).</p>	<p>no surcharge</p>	<p><b>Colour touch!</b>                      Please state the colour touch version!</p> <p><b>Surcharge for mirror per hinge-door:</b></p>

# Combined folding-door wardrobes with integrated functional TV unit – Basic and extension units

For each project please remember to leave a 2.0 cm gap to the ceiling and at the side for assembly!

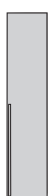
Please state handle version!

LA VELA II

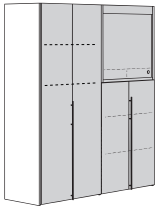
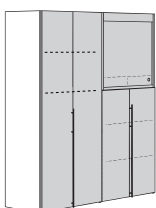
<p>Height: 229.6 cm (with passepartout 233.9 cm; with top LED lamp 238.9 cm), height reductions not possible.                  Width: see table (with passepartout + 3.1 cm each side)                  Depth: 61.0 cm (with top LED lamp 69.0 cm)                  Interior fittings per unit: see below; all interior fittings are in a standard <b>white lacquer</b> version.                  Folding- and hinge-doors with chrome handles; wardrobe doors with optional mirror (at surcharge) or in colour touch (no surcharge).                  The surcharge for the passepartout frame of the basic units includes the left- and right-hand vertical frame as well as the horizontal frame, the surcharge for the extension units only includes the horizontal frame. When adding on extension units, the right-hand frame of the passepartout of the basic unit is used as the end unit of the complete combination.  <b>The passepartout unit is full-length up to 302 cm width.</b></p>		<p><b>Surcharge for passepartout</b></p> 	<p><b>Surcharge for top LED lamp</b></p> <p>1 lamp per unit</p> <p>Information on the energy class: see page 89 below!</p> 	<p><b>Colour touch</b>                  Each wardrobe door can be fitted with an optional colour touch (high-gloss white or high-gloss sand; no surcharge; sliding-door not available in high-gloss white and high-gloss sand).</p> 	<p><b>Surcharge for mirror</b>                  Each wardrobe door can be fitted with an optional mirror (vertical facet), for which is surcharge is made.</p> 
<p><b>Basic units</b> with 2 outer side sections (each 2 cm thick)                  For each wardrobe combination, the first element on the left is considered to be the basic unit, incorporating both outer side-sections. One can only include one basic unit in each combination. When adding on extension units, the right-hand side-section of the basic unit is employed as the end side-section of the complete combination.</p>	<p>Price group</p>	<p>Please also note the functional and high-quality <b>wardrobe interior fittings</b> as well as the special articles and possible <b>special-sized products</b> in the separate chapters on "Wardrobe interior fittings" and "Special products".</p>			
<p><b>Combined folding-door wardrobes with integrated functional TV unit</b>                  Left-hand type (L):                  left folding-door wardrobe: doors with left hinge; with 2 fitted shelves, 40 cm deep, and 1 clothes rod;                  right functional TV unit: top TV compartment with horizontal sliding-door (sliding-door opens to left, sliding-door in front version, frame in carcass version); usable inside space behind sliding-door: 80.1 cm high, 93.0 cm wide, 29.0 cm deep, with optional flat screen support (at surcharge, see below); below hinge-doors with 2 fitted shelves                  Right-hand type (R): right folding-door wardrobe; left functional TV unit (sliding-door opens to right)                  If a different wood/lacquer version is required of the combined folding-door wardrobes with integrated functional TV unit for the folding-doors, hinge-doors or the top sliding-door please state this clearly in the order. When versions from different price groups are exchanged, the higher price group is charged.                  Sliding-door is not available in high-gloss white and high-gloss sand!</p>  <p>202 cm wide</p>	<p>I II</p>	<p>A 2411 L A 2412 R</p>	<p>363</p>	<p>381 2 lamps</p>	<p>Please mark exactly in the front sketch or state in the order (from the left) which hinge-/folding-door wings are to be fitted in which colour touch (optionally high-gloss white or high-gloss sand).</p> <p>Please mark exactly in the front sketch or state in the order (from the left) which hinge-/folding-door wings are to be fitted with a mirror.</p>
<p><b>Extension units</b> with 1 centre partition (2 cm thick)</p>				<p>no surcharge</p>	<p><b>Surcharge for mirror per hinge-/folding-door wing:</b></p>
<p><b>Combined folding-door wardrobes with integrated functional TV unit</b>                  Left-hand type (L):                  left folding-door wardrobe: doors with left hinge; with 2 fitted shelves, 40 cm deep, and 1 clothes rod;                  right functional TV unit: top TV compartment with horizontal sliding-door (sliding-door opens to left, sliding-door in front version, frame in carcass version); usable inside space behind sliding-door: 80.1 cm high, 93.0 cm wide, 29.0 cm deep, with optional flat screen support (at surcharge, see below); below hinge-doors with 2 fitted shelves                  Right-hand type (R): right folding-door wardrobe; left functional TV unit (sliding-door opens to right)                  If a different wood/lacquer version is required of the combined folding-door wardrobes with integrated functional TV unit for the folding-doors, hinge-doors or the top sliding-door please state this clearly in the order. When versions from different price groups are exchanged, the higher price group is charged.                  Sliding-door is not available in high-gloss white and high-gloss sand!</p>  <p>200 cm wide</p>	<p>I II</p>	<p>A 0411 L A 0412 R</p>	<p>364</p>	<p>383 2 lamps</p>	<p><b>Colour touch!</b>                  Please state the colour touch version!</p>

## Flat screen support for fitting on rear wall of functional TV unit behind sliding-door

	<p><b>Flat screen support WTL6</b>                  for fitting on rear wall of functional TV unit behind sliding-door.</p> <p>The flat screen support can be adjusted 3-dimensionally. It is suitable for flat screens with a screen diagonal of 102-216 cm (40"-85"; please observe the usable dims. of the TV compartment; see above); max. load 45 kg.                  Go to <a href="http://www.vivanco.de">www.vivanco.de</a> to check if your flat screen can be fitted on this flat screen support. Enter the name WTL6. After a few steps you can see if your flat screen TV is compatible with the flat screen support. Suitable for curved TV's.                  Flat screen support compatible with VESA Norm standard:                  min.: 200 x 200 mm, max.: 600 x 400 mm</p>	<p>9705</p>
---	---	-------------



# Intermediate unit

For each project please remember to leave a 2.0 cm gap to the ceiling and at the side for assembly!

Please state handle version!

List of versions: see page 88

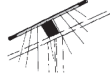
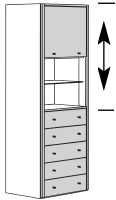
<p><b>Height: 229.6 cm</b> (with passepartout 233.9 cm; with top LED lamp 238.9 cm), height reductions not possible.  <b>Width: 82.2 cm</b> (width reductions not possible)  <b>Depth: 61.0 cm</b> (with top LED lamp 69.0 cm)</p> <p>Interior fittings per unit: see below.</p> <p>The surcharge for the passepartout frame only includes the horizontal frame.</p> <p><b>Only suitable as an intermediate unit (between two wardrobe units).</b></p>	<b>Price group</b>		<p><b>Surcharge for passepartout</b></p> 	<p><b>Surcharge for top LED lamp</b></p> <p>1 lamp per unit</p> <p>Information on the energy class: see page 89 below!</p> 
 <p><b>Intermediate unit</b></p> <p><b>Top:</b> open compartments, 1 fitted wooden shelf (not adjustable), 1 fitted glass shelf; vertical sliding-door in front version, frames and interior fittings in carcass version.          Inside height: top compartment 63.2 cm; bottom compartment 63.0 cm; inside width: 75.2 cm; inside depth: 51.5 cm</p> <p><b>Below:</b> 5 drawers (inside depth: 48.5 cm)          Drawer frames and drawer carcass in standard grey</p> <p>If a different wood/lacquer version is required for the lower drawers of the intermediate unit compared to the top sliding-door, please state this clearly in the order. When versions from different price groups are exchanged, the higher price group is charged.</p> <p>Fronts are not available in high-gloss white and high-gloss sand!</p>	<b>Price group</b>	<p style="text-align: center;"><b>A 070</b></p>	<p style="text-align: center;"><b>362</b></p>	<p style="text-align: center;"><b>382</b></p>

# Centre partition with integrated swing-out clothes rod

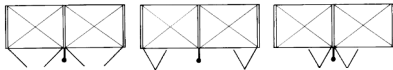
	<p><b>Surcharge for centre partition with integrated swing-out clothes rod</b></p> <p><b>Height reduction down to 201 cm height without surcharge!</b></p> <p>Centre partition 4.7 cm thick; clothes rod with clothes hooks in metal, optionally in aluminium colour or chrome gloss.</p> <p>Please note that the total width of the hinge-/folding-door wardrobes is increased by 2.7 cm when this centre partition is included. Cannot be used as an outer side section or be placed beside an intermediate unit or a corner wardrobe.</p> <p><b>Example of use:</b></p> 									
	<table border="1" style="width: 100%;"> <thead> <tr> <th></th> <th>aluminium colour</th> <th>chrome gloss</th> </tr> </thead> <tbody> <tr> <td style="text-align: center;">I</td> <td style="text-align: center;"><b>681</b></td> <td style="text-align: center;"><b>781</b></td> </tr> <tr> <td style="text-align: center;">II</td> <td></td> <td></td> </tr> </tbody> </table>		aluminium colour	chrome gloss	I	<b>681</b>	<b>781</b>	II		
	aluminium colour	chrome gloss								
I	<b>681</b>	<b>781</b>								
II										

# Beds-on-legs in sleep surface height 1 and 2 and hovering beds

Bed accessories  
see page 99!

LA VELA II

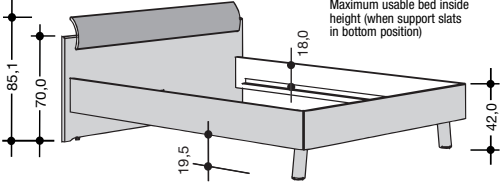

Please also note the mattresses and base frames in the separate chapter "SLEEPING SYSTEMS"!

Bed-on-legs in sleep surface height 1 Beds incl. support slats for base frames and mattresses • Adjustable in height by 3.2 cm downwards and upwards • Usable bed inside height (see here the information in the "Special-sized products" chapter): max. 18.0 cm  Top headboard section in different version: The top profiled headboard section of the bed can also be ordered optionally in a different version. When versions from different price groups are exchanged, the higher price group is charged. Top headboard section in colour touch: The top profiled headboard section of the bed can also be ordered optionally in white lacquer or sand lacquer (no surcharge). Top headboard section in leather: The top profiled headboard section of the bed can also be ordered optionally in high-grade leather (100% Nappa leather, pigmented; optionally in white, sand or nougat). Surcharge:  Please be sure to state in the order!	Inside dims.	Outside dims.	Type no.	Price group	
				I	II
	90 x 190	106 x 196	812		
	100 x 190	116 x 196	813		
	120 x 190	136 x 196	814		
	140 x 190	156 x 196	815		
	160 x 190	176 x 196	816		
	180 x 190	196 x 196	817		
	200 x 190	216 x 196	818		
	90 x 200	106 x 206	822		
	100 x 200	116 x 206	823		
	120 x 200	136 x 206	824		
	140 x 200	156 x 206	825		
	160 x 200	176 x 206	826		
	180 x 200	196 x 206	827		
	200 x 200	216 x 206	828		
	90 x 210	106 x 216	832		
	100 x 210	116 x 216	833		
	120 x 210	136 x 216	834		
	140 x 210	156 x 216	835		
160 x 210	176 x 216	836			
180 x 210	196 x 216	837			
200 x 210	216 x 216	838			
90 x 220	106 x 226	842			
100 x 220	116 x 226	843			
120 x 220	136 x 226	844			
140 x 220	156 x 226	845			
160 x 220	176 x 226	846			
180 x 220	196 x 226	847			
200 x 220	216 x 226	848			
<b>Bed-on-legs in sleep surface height 2</b> Beds incl. support slats for base frames and mattresses • Adjustable in height by 3.2 cm downwards and upwards • Usable bed inside height (see here the information in the "Special-sized products" chapter): max. 18.0 cm  Top headboard section in different version: The top profiled headboard section of the bed can also be ordered optionally in a different version. When versions from different price groups are exchanged, the higher price group is charged. Top headboard section in colour touch: The top profiled headboard section of the bed can also be ordered optionally in white lacquer or sand lacquer (no surcharge). Top headboard section in leather: The top profiled headboard section of the bed can also be ordered optionally in high-grade leather (100% Nappa leather, pigmented; optionally in white, sand or nougat). Surcharge:  Please be sure to state in the order!	90 x 190	106 x 199	8125		
	100 x 190	116 x 199	8135		
	120 x 190	136 x 199	8145		
	140 x 190	156 x 199	8155		
	160 x 190	176 x 199	8165		
	180 x 190	196 x 199	8175		
	200 x 190	216 x 199	8185		
	90 x 200	106 x 209	8225		
	100 x 200	116 x 209	8235		
	120 x 200	136 x 209	8245		
	140 x 200	156 x 209	8255		
	160 x 200	176 x 209	8265		
	180 x 200	196 x 209	8275		
	200 x 200	216 x 209	8285		
	90 x 210	106 x 219	8325		
	100 x 210	116 x 219	8335		
	120 x 210	136 x 219	8345		
	140 x 210	156 x 219	8355		
160 x 210	176 x 219	8365			
180 x 210	196 x 219	8375			
200 x 210	216 x 219	8385			
90 x 220	106 x 229	8425			
100 x 220	116 x 229	8435			
120 x 220	136 x 229	8445			
140 x 220	156 x 229	8455			
160 x 220	176 x 229	8465			
180 x 220	196 x 229	8475			
200 x 220	216 x 229	8485			
<b>Hovering bed</b> Beds incl. support slats for base frames and mattresses • Adjustable in height by 3.2 cm downwards and upwards • Usable bed inside height (see here the information in the "Special-sized products" chapter): max. 16.5 cm  Top headboard section in different version: The top profiled headboard section of the bed can also be ordered optionally in a different version. When versions from different price groups are exchanged, the higher price group is charged. Top headboard section in colour touch: The top profiled headboard section of the bed can also be ordered optionally in white lacquer or sand lacquer (no surcharge). Top headboard section in leather: The top profiled headboard section of the bed can also be ordered optionally in high-grade leather (100% Nappa leather, pigmented; optionally in white, sand or nougat). Surcharge:  Please be sure to state in the order!	90 x 190	106 x 196	412		
	100 x 190	116 x 196	413		
	120 x 190	136 x 196	414		
	140 x 190	156 x 196	415		
	160 x 190	176 x 196	416		
	180 x 190	196 x 196	417		
	200 x 190	216 x 196	418		
	90 x 200	106 x 206	422		
	100 x 200	116 x 206	423		
	120 x 200	136 x 206	424		
	140 x 200	156 x 206	425		
	160 x 200	176 x 206	426		
	180 x 200	196 x 206	427		
	200 x 200	216 x 206	428		
	90 x 210	106 x 216	432		
	100 x 210	116 x 216	433		
	120 x 210	136 x 216	434		
	140 x 210	156 x 216	435		
160 x 210	176 x 216	436			
180 x 210	196 x 216	437			
200 x 210	216 x 216	438			
90 x 220	106 x 226	442			
100 x 220	116 x 226	443			
120 x 220	136 x 226	444			
140 x 220	156 x 226	445			
160 x 220	176 x 226	446			
180 x 220	196 x 226	447			
200 x 220	216 x 226	448			

# Compact beds

Please also note the mattresses and base frames in the separate chapter "SLEEPING SYSTEMS"!

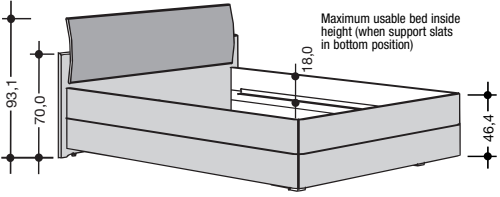
List of versions: see page 88

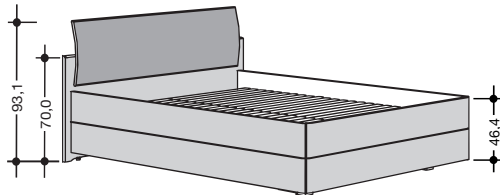
<b>Compact bed</b> Beds incl. support slats for base frames and mattresses • Adjustable in height by 3.2 cm downwards and upwards • Usable bed inside height (see here the information in the "Special-sized products" chapter): max. 18.0 cm  <b>Top headboard section in different version:</b> The top profiled headboard section of the bed can also be ordered optionally in a different version. When versions from different price groups are exchanged, the higher price group is charged. <b>Top headboard section in colour touch:</b> The top profiled headboard section of the bed can also be ordered optionally in white lacquer or sand lacquer (no surcharge). <b>Top headboard section in leather:</b> The top profiled headboard section of the bed can also be ordered optionally in high-grade leather (100% Nappa leather, pigmented; optionally in white, sand or nougat). Surcharge:  <b>Please be sure to state in the order!</b>  	<b>Inside dims.</b>	<b>Outside dims.</b>	<b>Type no.</b>	<b>Price group</b>	
				<b>I</b>	<b>II</b>
 <div style="border: 1px solid black; padding: 5px; width: fit-content; margin-top: 10px;"> <b>Colour touch!</b>                      Please state the colour touch version!                 </div>	90 x 190	106 x 199	<b>612</b>		
	100 x 190	116 x 199	<b>613</b>		
	120 x 190	136 x 199	<b>614</b>		
	140 x 190	156 x 199	<b>615</b>		
	160 x 190	176 x 199	<b>616</b>		
	180 x 190	196 x 199	<b>617</b>		
	200 x 190	216 x 199	<b>618</b>		
	90 x 200	106 x 209	<b>622</b>		
	100 x 200	116 x 209	<b>623</b>		
	120 x 200	136 x 209	<b>624</b>		
	140 x 200	156 x 209	<b>625</b>		
	160 x 200	176 x 209	<b>626</b>		
	180 x 200	196 x 209	<b>627</b>		
	200 x 200	216 x 209	<b>628</b>		
	90 x 210	106 x 219	<b>632</b>		
	100 x 210	116 x 219	<b>633</b>		
	120 x 210	136 x 219	<b>634</b>		
	140 x 210	156 x 219	<b>635</b>		
160 x 210	176 x 219	<b>636</b>			
180 x 210	196 x 219	<b>637</b>			
200 x 210	216 x 219	<b>638</b>			
90 x 220	106 x 229	<b>642</b>			
100 x 220	116 x 229	<b>643</b>			
120 x 220	136 x 229	<b>644</b>			
140 x 220	156 x 229	<b>645</b>			
160 x 220	176 x 229	<b>646</b>			
180 x 220	196 x 229	<b>647</b>			
200 x 220	216 x 229	<b>648</b>			
<b>Compact bed with hülstaflex comfort base frame and with linen box</b> Beds incl. support slats for base frames and mattresses • Adjustable in height by 3.2 cm downwards and upwards • Usable bed inside height (see here the information in the "Special-sized products" chapter): max. 18.0 cm  Linen box (inside veneer, with ventilation holes); hülstaflex comfort base frame, adjustable back and foot sections. The linen box is accessible by swinging up the foot section (LIFT function by gas pressure spring).  Notes on top profiled headboard section in a different version, in colour touch or in high-grade leather: see above!   <div style="border: 1px solid black; padding: 5px; width: fit-content; margin-top: 10px;"> <b>Colour touch!</b>                      Please state the colour touch version!                 </div> <p style="text-align: center;">with linen box</p> <p>Note:                      For bed widths of 90 to 140 cm: with 1 base frame                      For bed widths of 160 to 200 cm: with 2 base frames</p>	90 x 190	106 x 199	<b>6126</b>		
	100 x 190	116 x 199	<b>6136</b>		
	120 x 190	136 x 199	<b>6146</b>		
	140 x 190	156 x 199	<b>6156</b>		
	160 x 190	176 x 199	<b>6166</b>		
	180 x 190	196 x 199	<b>6176</b>		
	200 x 190	216 x 199	<b>6186</b>		
	90 x 200	106 x 209	<b>6226</b>		
	100 x 200	116 x 209	<b>6236</b>		
	120 x 200	136 x 209	<b>6246</b>		
	140 x 200	156 x 209	<b>6256</b>		
	160 x 200	176 x 209	<b>6266</b>		
	180 x 200	196 x 209	<b>6276</b>		
	200 x 200	216 x 209	<b>6286</b>		
	90 x 210	106 x 219	<b>6326</b>		
	100 x 210	116 x 219	<b>6336</b>		
	120 x 210	136 x 219	<b>6346</b>		
	140 x 210	156 x 219	<b>6356</b>		
	160 x 210	176 x 219	<b>6366</b>		
	180 x 210	196 x 219	<b>6376</b>		
	200 x 210	216 x 219	<b>6386</b>		
	90 x 220	106 x 229	<b>6426</b>		
	100 x 220	116 x 229	<b>6436</b>		
	120 x 220	136 x 229	<b>6446</b>		
140 x 220	156 x 229	<b>6456</b>			
160 x 220	176 x 229	<b>6466</b>			
180 x 220	196 x 229	<b>6476</b>			
200 x 220	216 x 229	<b>6486</b>			

### Atmospheric lamp for beds

Switch in left and right side of the headboard  
 Later fitting not possible.

This luminaire contains built-in LED lamps of the energy classes A++ to A.  
 The lamps cannot be changed in the luminaire.  
 12 V; 3 W per metre length; dimmable

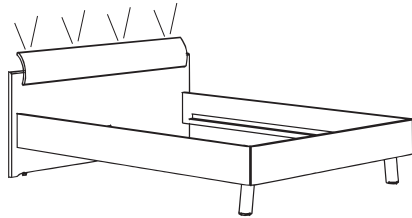

for the headboard of the bed with an inside width of:

90 cm	100 cm	120 cm	140 cm	160 cm	180 cm	200 cm
<b>8909</b>	<b>8910</b>	<b>8912</b>	<b>8914</b>	<b>8916</b>	<b>8918</b>	<b>8920</b>

### Swing-out LED bedside lamp with swan neck

Chrome colour

For fitting in headboard (left and/or right).

This luminaire contains built-in LED lamps of the energy classes A++ to A.  
 The lamps cannot be changed in the luminaire.  
 12 V; 2.5 W

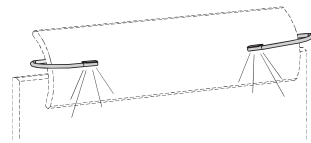

Set of 1

Set of 2

**978**

**979**

### LED bedside lamp (pair)

with motion sensor for switching on and off (no time interval)

This luminaire contains built-in LED lamps of the energy classes A++ to A.  
 The lamps cannot be changed in the luminaire.  
 12 V; 1.8 W

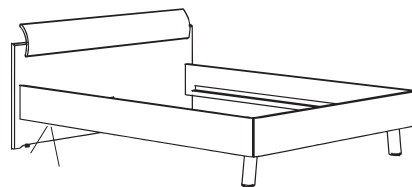

**894**

### Mobile linen box

standard black  
 120 x 80 x 14.5 cm

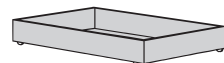

**507**

No motor-driven base frames (except: hülstafflex premium Motor)  
 can be fitted in combination with the linen box.

### Add-on foot section

can be adapted to fit all LA VELA II beds

21 cm high

Protrusion above bed frame: 5.5 cm

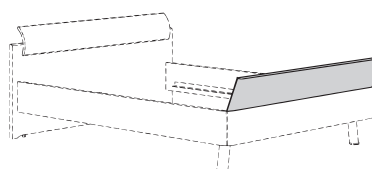

for bed widths

Type no.

Price group

I

II









90 cm  
 100 cm  
 120 cm  
 140 cm  
 160 cm  
 180 cm  
 200 cm

**872**  
**873**  
**874**  
**875**  
**876**  
**877**  
**878**

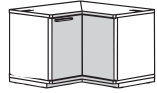
# Ancillary units

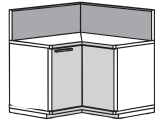
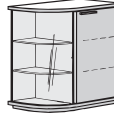
Please state handle version!

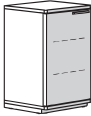
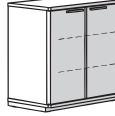
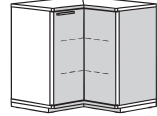
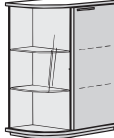
List of versions: see page 88

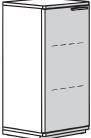
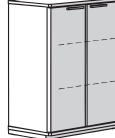
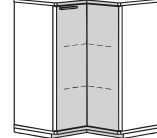
<b>Consoles</b> 41.2 cm or 49.2 cm high 40.0 cm deep	<b>Price group</b>  I II	<b>Console</b> with 2 drawers; 41.2 cm high  		<b>Console</b> with 2 drawers; 49.2 cm high  		<b>LED inside drawer lamps, electric sockets, cylinder lock</b>  <b>LED inside drawer lamps</b> Consoles with drawers can be fitted with optional LED inside drawer lamps (7.5 V, 1.0 W powered by standard AAA 1.5 V batteries included - rechargeable batteries not possible; with automatic on/off switch). Please state exactly in your order which drawer is to be fitted with LED inside drawer lamps. Surcharge for LED inside drawer lamps per drawer: This type of luminaire is excepted from obligatory labelling in accordance with EU-VO 874/2012 guidelines (Reason: battery-operated and/or <30 Lumen).  <b>Electric sockets</b> Apart from the standard version with one electric socket, consoles with top panel can also be supplied as follows: a) without socket as a special product at the same price b) with 2 or more electric sockets at a surcharge for each additional socket of	<b>Corner console, accessible</b> with 1 wooden door with 180° opening angle; 49.2 cm high    70 x 70 cm wide	
		45 cm wide	70 cm wide	45 cm wide	70 cm wide			5151
<b>Consoles with top panel</b> 70.0 cm high 40.0 cm deep  <b>Colour touch:</b> The top panel of consoles can also be supplied without surcharge in an optional <b>colour touch</b> (white lacquer or sand lacquer). Please be sure to state in the order!  <b>Colour touch!</b> Please state the colour touch version!	I II	<b>Console</b> with 2 drawers and 1 socket in top panel, optionally right (R) or left (L; as shown)  		<b>Console</b> with 2 drawers and 1 socket in top panel, optionally right (R) or left (L; as shown)   L		<b>Cylinder lock</b> If required, the top drawer of all consoles and chests can be fitted with a cylinder lock. Surcharge for cylinder lock:  <b>Please note:</b> It is not possible to fit inside drawer lamps and a cylinder lock inside the same top drawer!	<b>Corner console, accessible</b> with 1 wooden door with 180° opening angle    70 x 70 cm wide	
		45 cm wide	70 cm wide	45 cm wide	70 cm wide			5154
<b>Chests</b> 70.0 cm high 40.0 cm deep	I II	<b>Profiled end chest</b> with 1 wooden door, 1 profiled bronzed glass door (glass door optionally right (R) or left (L; as shown) as well as 2 fitted wooden and 2 fitted glass shelves (satinised glass)    70 cm wide		<b>Chest</b> with 3 drawers    45 cm wide   70 cm wide		<b>Chest</b> with 1 wooden door and 2 fitted wooden shelves    45 cm wide	<b>Chest</b> with 2 wooden doors and 2 fitted wooden shelves    70 cm wide   90 cm wide	<b>Corner chest, accessible</b> with 1 wooden door with 180° opening angle and 2 fitted wooden shelves    70 x 70 cm wide
		51751 L 51752 R	5005 5015	51151 L 51152 R	5115 5125	5155		
<b>Chests</b> 90.8 cm high 40.0 cm deep	I II	<b>Profiled end chest</b> with 1 wooden door, 1 profiled bronzed glass door (glass door optionally right (R) or left (L; as shown) as well as 2 fitted wooden and 2 fitted glass shelves (satinised glass)    70 cm wide		<b>Chest</b> with 4 drawers    45 cm wide   70 cm wide		<b>Chest</b> with 1 wooden door and 2 fitted wooden shelves    45 cm wide	<b>Chest</b> with 2 wooden doors and 2 fitted wooden shelves    70 cm wide   90 cm wide	<b>Corner chest, accessible</b> with 1 wooden door with 180° opening angle and 2 fitted wooden shelves    70 x 70 cm wide
		51771 L 51772 R	5007 5017	51171 L 51172 R	5117 5127	5157		



# Chests, bench

Please state handle version!

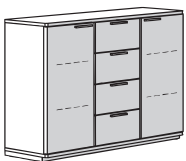
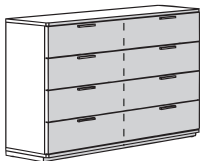
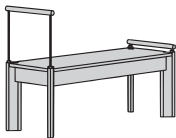
# LA VELA II

<b>Chests</b> 90.8 cm high 40.0 cm deep  <b>Bench</b> Total height: 54.5 cm Seat height: 45.5 cm Depth: 43.2 cm	Price group          I II	<b>Utility chest</b> with 4 drawers, 2 wooden doors and 2 fitted wooden shelves each    135 cm wide  <b>521</b>	<b>Chest of drawers</b> with 4 drawers and split drawer frames    150 cm wide  <b>522</b>	<b>Bench</b> with pull-out valet (both sides)  Extended height: 30.5 cm; not extendable    123.2 cm wide  <b>524</b>

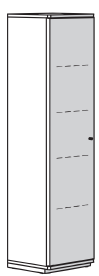
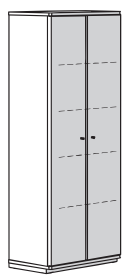
# High chests, accessories

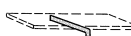
<b>High chests</b> with knobs  174.0 cm high 40.0 cm deep  Door hinge optionally left (L) or right (R)  <b>Accessories</b>	Price group          I II	<b>High chest</b> with 1 wooden door and 4 fitted wooden shelves   L  45 cm wide  <b>51191 L</b> <b>51192 R</b>	<b>High chest</b> with 2 wooden doors and 4 fitted wooden shelves    70 cm wide  <b>5119</b>	Price group          I II	<b>Fitted shelf</b>    for 45 cm width   for 70 cm width  <b>904</b>   <b>905</b>
					<b>Pull-out clothes rod</b> (for fitting below fitted shelf)    <b>907</b>

# Utility/dressing tables

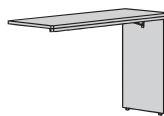
<b>Utility/dressing tables</b>  42.2 cm deep  for resting on both sides or on one side, optionally right (R) or left (L; as shown) of 70.0 cm high chests	Price group          I II	<b>Utility/dressing table</b> for resting on both sides of chests    140 cm wide   170 cm wide  <b>53140</b>   <b>53170</b>		<b>Utility/dressing table</b> for resting on one side of chest   L  115 cm wide   140 cm wide   170 cm wide  <b>54111 L</b>   <b>54141 L</b>   <b>54171 L</b> <b>54112 R</b>   <b>54142 R</b>   <b>54172 R</b>		

# Wall units

List of versions: see page 88

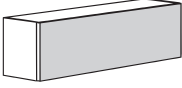
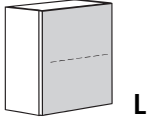
<p><b>Wall units</b> 38.4 or 70.0 cm high 35.0 cm deep</p> <p>Wall units in matching version or in <b>colour touch</b> (optionally white or sand), for fitting anywhere on walls</p> <p>Flap and door with knob (for wood/lacquer versions) or with receding grip (for rear-lacquered glass fronts; as illustrated)</p> <p>Max. load: 30 kg</p> <p>The wall units can not be fitted directly on top of one another.</p>	<p>Price group</p> <p>I II</p>	<p><b>Wall unit with flap</b> (with 1 centre partition); 38.4 cm high</p>  <p>140 cm wide</p> <p><b>Colour touch!</b></p>			<p><b>Wall unit with 1 door;</b> 1 fitted wooden shelf; 70.0 cm high</p>  <p>70 cm wide</p> <p><b>Colour touch!</b></p>		
		Carcase and front in matching version	Carcase in white lacquer, front in rear-lacquered glass, white	Carcase in sand lacquer, front in rear-lacquered glass, sand	Carcase and front in matching version	Carcase in white lacquer, front in rear-lacquered glass, white	Carcase in sand lacquer, front in rear-lacquered glass, sand
		<b>580</b>	<b>581</b>	<b>582</b>	<b>5831 L</b> <b>5832 R</b>	<b>5841 L</b> <b>5842 R</b>	<b>5851 L</b> <b>5852 R</b>

# Open wall units, box drawer

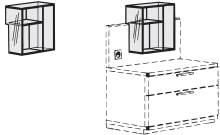
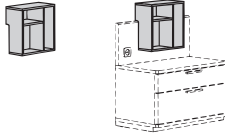
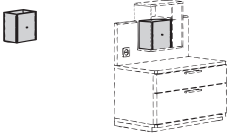
<p><b>Open wall units</b> 32.0 cm high 16.0 cm deep</p> <p>Open wall unit of bronzed glass, in matching version or in <b>colour touch</b> (optionally white lacquer or sand lacquer)</p> <p>Wall units for fitting on top panels of consoles</p> <p><b>Box drawer</b> 19.0 cm high 12.8 cm deep</p> <p>For fitting in bottom left compartment of open wall units</p> <p>Box drawers in matching version or in <b>colour touch</b> (optionally white lacquer or sand lacquer)</p>	<p>Price group</p> <p>I II</p>	<p><b>Open glass wall unit</b></p> <p>Example of use:</p>  <p>32.0 cm wide</p>		<p><b>Open wooden wall unit</b></p> <p>Example of use:</p>  <p>32.0 cm wide</p> <p><b>Colour touch!</b></p>			<p><b>Box drawer</b></p> <p>Example of use:</p>  <p>32.0 cm wide</p> <p><b>Colour touch!</b></p>		
		Wall unit of bronzed glass		Wall unit in matching version	Wall unit in white lacquer	Wall unit in sand lacquer	Box drawer in matching version	Box drawer in white lacquer	Box drawer in sand lacquer
		<b>560</b>	<b>561</b>	<b>5611</b>	<b>5612</b>	<b>564</b>	<b>5641</b>	<b>5642</b>	

# Wall shelves

<p><b>Wall shelves</b> Thickness: 3.3 cm Depth: 21.5 cm</p>	<p>Price group</p> <p>I II</p>	<p><b>Wall shelves</b></p> 				
		45 cm wide	70 cm wide	90 cm wide	135 cm wide	150 cm wide
		<b>5045</b>	<b>5070</b>	<b>5090</b>	<b>50135</b>	<b>50150</b>

# Mirrors

# LA VELA II

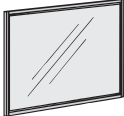
<b>Mirrors</b> all round facet Thickness: 2.5 cm	<b>Price group</b>  I II	<b>Mirrors</b>	
		 90 x 70 cm <b>526</b>	 70 x 115 cm <b>527</b>



# hülsta fabric collection

Modern cover fabrics, hard wearing and easy to care for in a high-quality.

Type of material Fabric no.	Material identification Colour	Price group
<b>Smooth fabric of microfibres</b>	<b>top: 100% polyester, below: 70% polyester, 30% cotton</b>	
S305	dark grey / anthracite	I
S306	mauve / lilac	I
S308	light grey	I
S315	brown grey / taupe	I
S316	alabaster / beige	I
S318	marine / blue	I
S319	coal / black	I
<b>Smooth fabric lined with fleece</b>	<b>top: 100% polyester, below: 100% polyester, polar fleece</b>	
S330	maize yellow	I
S331	almond white	I
S332	smoked quartz / taupe	I
S333	pepper	I
S334	slate	I
S336	sesame	I
S338	carambola	I
S339	golden olive	I
<b>Chenille smooth fabric</b>	<b>73% polyester, 25% acrylic, 2% viscose</b>	
S347	cream	I
S348	nut	I
S349	coffee	I
S350	black mocca	I
S351	khaki	I
S353	platinum grey	I
S354	brown anthracite	I
S355	deep brown	I
<b>Smooth fabric</b>	<b>49% polyester, 30% acrylic, 21% cotton</b>	
S356	white	I
S357	brilliant sand	I
S358	light brown	I
S359	chestnut	I
S362	medium blue	I
S363	grey blue	I
S364	grey black	I
<b>Smooth fabric with wool effect</b>	<b>100% Polyester</b>	
S230	light grey	I
S231	grey brown	I
S232	marine blue	I
S233	anthracite	I
S234	dark grey blue	I
S235	grey violet	I
<b>Smooth fabric, roughened</b>	<b>65% wool, 20% polyamide, 15% kashmir</b>	
S521	anthracite	II
S523	taupe	II
S524	grey	II
S528	beige	II
<b>Smooth fabric lined with fleece</b>	<b>top: 100% polyester, below: 100% polyester, polar fleece</b>	
S594	white	II
S595	smoky	II
S596	lemon	II
S597	tin	II
S598	pebble	II
S599	parchment	II

**NEW**

Shaded grey =

Fabrics with stain protection

Type of material Fabric no.	Material identification Colour	Price group
<b>Smooth fabric, roughened</b> S401 S402 S403 S404 S405 S406	<b>70% wool, 25% polyamide, 5% other fibres</b> brown blue petrol yellow violet pink	II II II II II II
<b>Smooth fabric with EverClean</b> S411 S412 S413 S414 S415 S416	<b>100% polyester</b> ivory dark brown anthracite quartz grey saffron brown beige	II II II II II II
<b>Smooth fabric, velvet</b> S421 S422 S423 S424 S425 S426	<b>92.5% polyester, 4.5% polyamide, 3% cotton</b> taupe sand tin black blue wine red grey white	II II II II II II
<b>Smooth fabric with linen</b> S500 S501 S502 S503 S504 S505 S506 S507	<b>91% polyester, 5% linen, 4% polypropylene</b> taupe anthracite blue green beige rose white cream white beige brown	II II II II II II II II
<b>Artificial leather</b> S431 S432 S433 S434 S436 S437 S438	<b>72% polyvinyl chloride, 28% cotton</b> white teal blue black brown grey dark brown taupe beige	II II II II II II II
<b>Artificial leather with structure</b> S450 S451 S452 S453 S454 S455 S456	<b>top: 100% polyurethane, below: 41% leather, 39% polyethylene, 20% cotton</b> cream white white dark brown taupe anthracite brown grey black	II II II II II II II
<b>Nappa leather</b> 5104 5105 5108 5119 5122 5123 5125	<b>100% Nappa leather, pigmented</b> anthracite black white nougat sand brown black grey	III III III III III III III

Plaids are not possible in artificial leather!

Plaids are not possible in artificial leather with structure!

Plaids are not possible in Nappa leather!



# Wardrobe interior fittings

With these high-quality interior fittings for wardrobes hülsta has developed a system that meets every individual furnishing needs. The great number of different unit types, a wide spectrum of sizes, as well as a variety of surface versions underline the great versatility and variability available. The wardrobe interior fittings can be used in every kind of wardrobe – hinge-door, folding-door and sliding-door wardrobes as well as in the MULTI-FORMA II room system. There are many different sets of drawers for quick and easy planning.

## Contents

	Page
Range introduction, list of versions	238
Fitted shelves, protective mat	239
Centre partition kits, clothes lift	240
Clothes rods, tie holders, trouser holders, inside mirror, fabric boxes	241
Important notes on fitting drawers in wardrobes	242-243
Sets of drawers	244-246
Fitting at any level	247-248
Accessories	249
Cover for sets of drawers	250
Wardrobe interior fittings in special width	251

## Functional units

A multitude of functional components are the main features of the wardrobe interior fittings:

- Fitted shelves for straight and profiled units, also for panorama units and corner units
- Clothes rods for straight units and corner units
- LED illuminated shelves for straight units and hinge-door corner wardrobe, with automatic switch
- Centre partition kits and clothes lift
- Tie and trouser holders, also extendable
- Inside mirror for fitting on inside of wardrobe doors
- Fabric boxes

## Drawers

For optimal use of wardrobes, all the drawers are available as single units or in sets. Because they can be fitted at any level it is possible to design wardrobe interior fittings individually.

- Drawers with wooden or glass front and shoe drawer
- Compartment for ties or linen for drawers with glass front
- Sets of drawers composed differently and made up of the units stated above
- For fitting at any level with carcasses, different drawers and accessories

## Quality features

- **hülsta-SoftFlow:** All drawers on hidden roller bearings with auto pull-in feature with brake as fully pull-out units
- Tie holder in high-quality chrome version
- Drawer frames in standard grey
- Simple assembly due to the use of special brackets
- All inside surfaces have a side distance piece to ensure easy opening when the doors are open
- All wooden components optionally in different versions



## List of versions

Model no.	Versions
973	White lacquer
974	Light interior veneer
975	Dark interior veneer

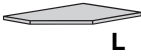
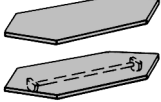
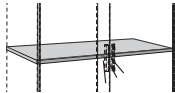
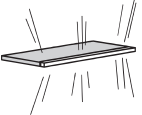
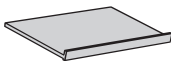

Please state in the order the name and the model number of the range which the wardrobe interior fittings are intended for.

## Handle versions

The drawer handles for the wardrobe interior fittings are delivered standard in the same version as the wardrobe door handles in which the interior fittings are incorporated (high-gloss chrome or matt chrome). If the wardrobe door handles are required in wood or lacquer versions, please state the version of the drawer handles for the interior fittings clearly in the order!

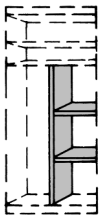
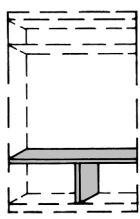
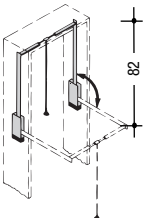
		for wardrobe inside widths	Type no.		
 <p><b>Fitted shelves</b> 2.3 cm thick (2.6 cm thick, including support strut for 118 to 198 cm width)</p>  <p>L</p>	<ul style="list-style-type: none"> <li>28 cm wide components only in combination with centre partition kit</li> </ul> <p>for straight units</p>	<ul style="list-style-type: none"> <li>28 cm</li> <li>38 cm</li> <li>48 cm</li> <li>58 cm</li> <li>68 cm</li> <li>78 cm</li> <li>88 cm</li> <li>98 cm</li> <li>108 cm</li> <li>118 cm</li> <li>128 cm</li> <li>133 cm</li> <li>138 cm</li> <li>148 cm</li> <li>158 cm</li> <li>198 cm</li> </ul>	<p>79001 79002 79003 790032 790088 79004 79005 79006 790065 790068 790077 790066 790078 790067 79007 79008</p>		
	<p>for profiled end units from MULTI-FORMA II</p>	<ul style="list-style-type: none"> <li>48 cm</li> <li>98 cm</li> </ul>	<p>790081 L 790082 R 790091 L 790092 R</p>		
 <p><b>Fitted corner shelf</b> for 45° corner unit, 2.3 cm thick</p>	<p>without clothes rod</p>		<p>79020</p>		
	<p>with clothes rod</p>		<p>79021</p>		
<p><b>NEW</b></p>  <p><b>LED illuminated shelf</b> 2.9 cm thick; with LED-lamp</p> <p>This luminaire contains built-in LED lamps of the energy classes A++ to A. The lamps cannot be changed in the luminaire. 12 V; 11.0 W</p>	<p>for straight units</p>	<ul style="list-style-type: none"> <li>98 cm</li> </ul>	<p>79436</p>		
 <p><b>LED illuminated shelf</b> 2.9 cm thick; with LED-lamp; with automatic switch and motion detector</p> <p>We do not recommend fitting these illuminated shelves in the MULTI-FORMA II room system.</p> <p>This luminaire contains built-in LED lamps of the energy classes A++ to A. The lamps cannot be changed in the luminaire. 12 V; 3.4-18.7 W</p>	<p>for straight units</p>	<ul style="list-style-type: none"> <li>38 cm</li> <li>48 cm</li> <li>58 cm</li> <li>68 cm</li> <li>78 cm</li> <li>88 cm</li> <li>98 cm</li> <li>108 cm</li> <li>118 cm</li> <li>128 cm</li> <li>133 cm</li> <li>138 cm</li> <li>148 cm</li> <li>158 cm</li> <li>198 cm</li> </ul>	<p>79332 79333 793302 793038 79334 79335 79336 793365 793368 793377 793366 793378 793367 79337 79338</p>		
	<p>for hinge-door corner wardrobe</p>	<p>without clothes rod</p>		<p>79339</p>	
		<p>with clothes rod</p>		<p>79340</p>	
 <p><b>Presentation shelf</b> 2.3 cm thick; with extra slat on the front rim, 6.0 cm high Fitted height: approx. 17.5 cm when fitted at an angle</p>	<p>for straight units</p>	<ul style="list-style-type: none"> <li>48 cm</li> <li>58 cm</li> <li>68 cm</li> <li>78 cm</li> <li>88 cm</li> <li>98 cm</li> <li>108 cm</li> </ul>	<p>79503 79502 79508 79504 79505 79506 795065</p>		
 <p><b>Protective mat</b> of silver-coloured plastic; for presentation shelves</p>	<p>for straight units</p>	<ul style="list-style-type: none"> <li>48 cm</li> <li>58 cm</li> <li>68 cm</li> <li>78 cm</li> <li>88 cm</li> <li>98 cm</li> <li>108 cm</li> </ul>	<p>79563 79562 79568 79564 79565 79566 795665</p>		

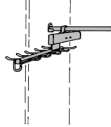
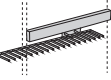
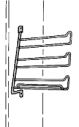
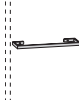
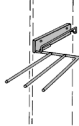
		for wardrobe inside widths	Type no.
 <p><b>Centre partition kit</b> for wardrobes with unit inside widths of 78, 88 and 98 cm, consisting of: 1 centre partition (153.0 cm high); 2 constructional shelves 48 cm wide (fitted optionally left or right)</p> <p>for 78 cm width: 48 cm wide compartment with 2 constructional shelves; 28 cm open compartment</p> <p>for 88 cm width: 48 cm wide compartment with 2 constructional shelves; 38 cm open compartment</p> <p>for 98 cm width: 48 cm wide compartment with 2 constructional shelves; 48 cm open compartment</p> <p>Additional extras: 28, 38, 48 cm wide fitted shelves, clothes rods as well as 48 cm wide drawers and sets</p>			<b>79130</b>
<p>If the centre partition kit is fitted in the MULTI-FORMA II room system, please add a "1" to the type number (e.g. 7913641). <b>Please state clearly in the order!</b></p>	<b>1 Raster high</b> Total height: 22.2 cm	138 cm 158 cm 198 cm	<b>791364</b> <b>791374</b> <b>791384</b>
 <p><b>Centre partition kit</b> for hinge- and folding-door wardrobes as well as for open carcass units of the MULTI-FORMA II room system with unit inside widths of 138, 158 and 198 cm, consisting of: 1 centre partition (always in centre under constructional shelf) and 1 constructional shelf</p> <p>for 138 cm width: two 68 cm wide compartments for 158 cm width: two 78 cm wide compartments for 198 cm width: two 98 cm wide compartments</p> <p>Drawers and sets must be fitted in the centre partition kit (see pages 244-248). The standard cover shelves of the sets of drawers are deducted from the price.</p>	<b>2 Raster high</b> Total height: 41.4 cm	138 cm 158 cm 198 cm	<b>791360</b> <b>791370</b> <b>791380</b>
	<b>3 Raster high</b> Total height: 60.6 cm	138 cm 158 cm 198 cm	<b>791361</b> <b>791371</b> <b>791381</b>
	<b>4 Raster high</b> Total height: 79.8 cm	138 cm 158 cm 198 cm	<b>791362</b> <b>791372</b> <b>791382</b>
	<b>5 Raster high</b> Total height: 99.0 cm	138 cm 158 cm 198 cm	<b>791363</b> <b>791373</b> <b>791383</b>
 <p><b>Clothes lift</b> Twin-arm, aluminium-coloured, swing-out clothes rod with brake mechanism Max. load: 10 kg</p>	for hinge-door wardrobes	68 cm 78 cm 98 cm 108 cm	<b>79183</b> <b>79184</b> <b>79186</b> <b>791865</b>
	for folding- and sliding-door wardrobes	78 cm 88 cm 98 cm 108 cm 118 cm	<b>78184</b> <b>78185</b> <b>78186</b> <b>781865</b> <b>781875</b>

		for wardrobe inside widths	Type no.		
	<p><b>Clothes rod</b> chrome, uniform tubular metal with two supports</p>	<ul style="list-style-type: none"> <li>● 28 cm wide components only in combination with centre partition kit</li> </ul> <p>for straight units or for profiled end units</p>	<ul style="list-style-type: none"> <li>● 28 cm</li> <li>38 cm</li> <li>48 cm</li> <li>58 cm</li> <li>68 cm</li> <li>78 cm</li> <li>88 cm</li> <li>98 cm</li> <li>108 cm</li> <li>118 cm</li> <li>128 cm</li> <li>133 cm</li> <li>138 cm</li> <li>148 cm</li> <li>158 cm</li> <li>198 cm</li> </ul>	<p><b>79011</b> <b>79012</b> <b>79013</b> <b>790182</b> <b>790018</b> <b>79014</b> <b>79015</b> <b>79016</b> <b>790165</b> <b>790168</b> <b>790177</b> <b>790166</b> <b>790178</b> <b>790167</b> <b>79017</b> <b>79018</b></p>	
	<p><b>Extendable tie holder</b> chrome, fitted on clothes rod and rear wall of wardrobe carcass for 22 ties 21.3 cm high, 11.6 cm wide, 50.0 cm deep</p>		<b>79142</b>		
	<p><b>Extendable tie holder</b> chrome, fitted on the inner side of wardrobe carcass for 17 ties 13.0 cm high, 9.0 cm wide, 54.0 cm deep</p>		<b>79145</b>		
	<p><b>Tie holder</b> chrome, fitted on the left inner side of wardrobe carcass for 18 ties 29.5 cm high, 25.0 cm wide, 8.0 cm deep</p>		<b>79144</b>		
	<p><b>Tie holder</b> chrome, fitted on the inner side of hinge-doors for 3 ties 1.3 cm high, 26.0 cm wide, 5.0 cm deep</p>		<b>79153</b>		
	<p><b>Extendable trouser holder</b> chrome, fitted on the inner side of wardrobe carcass for 3 pairs of trousers 26.0 cm high, 50.5 cm wide, 7.5 cm deep</p>		<b>79146</b>		
	<p><b>Inside mirror</b> fitted on the inner side of 229.6 and 268.0 cm high as well as 40 and 50 cm wide, straight hinge-doors Please state clearly in the order which hinge-doors are to be fitted with an inside mirror. The inside mirror cannot be fitted in MULTI-FORMA II wardrobes in design F and F plus.</p>		<b>79154</b>		
	<p><b>Fabric boxes</b> with leather grip; colours: black or sand 33.0 cm wide, 50.0 cm deep</p>	black	<p>8 cm high 16 cm high 24 cm high</p>	<p><b>79170</b> <b>79171</b> <b>79172</b></p>	
		sand	<p>8 cm high 16 cm high 24 cm high</p>	<p><b>79165</b> <b>79166</b> <b>79167</b></p>	

## Important notes on fitting drawers in wardrobes

Additional accessories (e.g. drawers, sets of drawers, etc.; see pages **244-248**) can be fitted in hinge-, folding- and sliding-door wardrobes as well as in the MULTI-FORMA II room system. These accessories must always be fitted on both sides of the wardrobe side sections or centre partitions, i.e. the accessories have the same width as the inside width of the appropriate wardrobe unit (see examples **1** and **3-6**). It is, however, also possible to fit stand-alone accessories fitted at one side only. In this case, a cover for a set of drawers must be ordered extra (see examples **2, 7** and **8**). It is not possible to fit accessories that stand alone at both sides!

We differentiate between accessories for hinge-door wardrobes and for the MULTI-FORMA II room system as well as accessories for folding- and sliding-door wardrobes in the wardrobe interior fittings.

Drawers in the accessories for **hinge-door wardrobes** and for the **MULTI-FORMA II room system** are fitted with narrow side-support panels at both sides (see each of the left-hand wardrobe units in examples **1** and **2**).

Since folding- or sliding-doors cannot be opened at the sides as far as hinge-doors for constructional reasons, the accessories for **folding- and sliding-door wardrobes** are fitted with a narrow support panel at one side and with a wide support panel at the other side. That is why the accessories for folding- and sliding-door wardrobes are divided into accessories as **"accessories left" = L** (i.e. the wide side-support panel is fitted on the left-hand side of the accessory), and **"accessories right" = R** (i.e. the wide side-support panel is fitted on the right-hand side of the accessory).

With **folding-door wardrobes**, the wide support panel of the accessory must be fitted on the side of the folding-door unit where the folding-doors are mounted (see each of the middle and right-hand wardrobe units in examples **1** and **2** as well as example **3**). Please note: A sideward distance of up to a max. 5 cm must be kept to the side wall so that the folding-doors can be opened widely enough. The space depends on the intended handle. We recommend getting advice from hülsta if necessary.

With **2- and 4-door sliding-door wardrobes**, the wide support panel of the accessory must always be fitted on the inside of the sliding-door unit (see examples **4** and **6**). The same applies to the outside units of a **3-door sliding-door wardrobe**. The accessory of the middle unit must always be fitted with the wide support panel on the left (see example **5**). If the accessory is fitted as a stand-alone unit at one side with a cover for a set of drawers (see examples **2, 7** and **8**), the same applies as described above.

If 2 sets of drawers are fitted adjacently please use the centre partition kit shown on page **240** (see example **3**). The standard cover shelves of the sets of drawers are deducted from the price.

**Please note:** The sketches on pages **244-248** show the accessories for hinge-door wardrobes (i.e. with narrow side-support panels at both sides)!

### Example 1 Hinge-/folding-door wardrobe

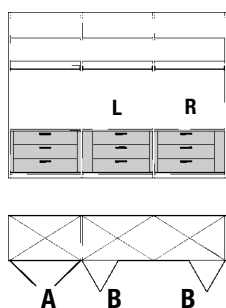

- A:** Accessory in hinge-door unit with narrow support panels at both sides
- B:** Accessory in folding-door unit with wide support panel at the side, where the door is mounted

### Example 2 Hinge-/folding-door wardrobe

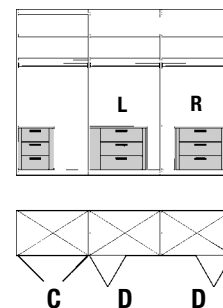

- C:** Accessory, stand-alone at one side, in hinge-door unit with narrow support panels at both sides
- D:** Accessory in folding-door unit, stand alone, at one side, with wide support panel at the side, where the door is mounted

### Example 3

Folding-door wardrobe:  
Panorama unit with 5 Raster high centre partition kit

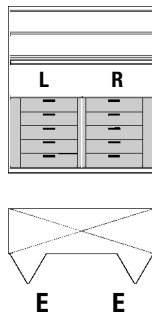

**E:** Accessory in folding-door wardrobe with wide support panel at the side, where the door is mounted

### Example 4

2-door sliding-door wardrobe

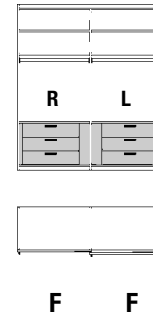

**F:** Accessory in sliding-door wardrobe with wide support panel at the side on the inside of the sliding-door unit

### Example 5

3-door sliding-door wardrobe

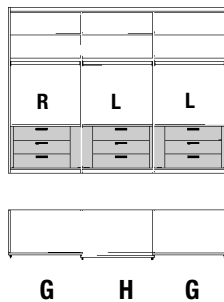

**G:** Accessory in sliding-door wardrobe with wide support panel at the side on the inside of the sliding-door unit  
**H:** Accessory in sliding-door wardrobe in the centre unit with a standard wide support panel on the left-hand side

### Example 6

4-door sliding-door wardrobe

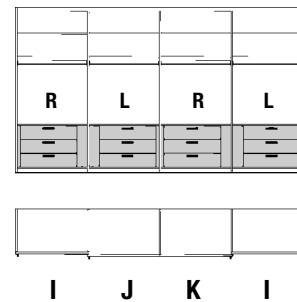

**I:** Accessory in sliding-door wardrobe with wide support panel at the side on the inside of the sliding-door unit  
**J:** Accessory in sliding-door wardrobe in the left-hand centre unit with a standard wide support panel on the left-hand side  
**K:** Accessory in sliding-door wardrobe in the right-hand centre unit with a standard wide support panel on the right-hand side

### Example 7

2-door sliding-door wardrobe

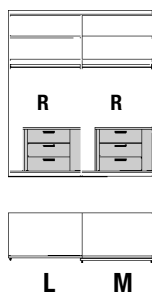

**L:** Accessory, stand-alone at one side, in sliding-door wardrobe with wide support panel at the side on the inside of the sliding-door unit  
**M:** Since the accessory in the right-hand unit of the sliding-door wardrobe is mounted as a stand-alone unit on the side and does not reach as far as the inside wall of the sliding-door unit, the wide support panel can also be fitted on the outer side wall of the sliding-door unit.

### Example 8

4-door sliding-door wardrobe

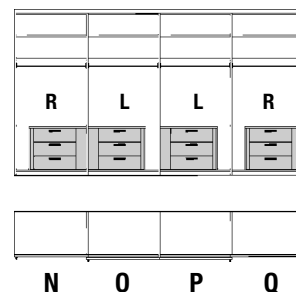







**N:** Accessory, stand-alone at one side, in sliding-door wardrobe with wide support panel at the side on the inside of the sliding-door unit  
**O:** Accessory, stand-alone at one side, in sliding-door wardrobe in the left-hand centre unit with a standard wide support panel on the left-hand side  
**P:** Accessory, stand-alone at one side, in sliding-door wardrobe in the right-hand centre unit with a standard wide support panel on the right-hand side  
**Q:** Since the accessory in the right-hand unit of the sliding-door wardrobe is mounted as a stand-alone unit on the side and does not reach as far as the inside wall of the sliding-door unit, the wide support panel can also be fitted on the outer side wall of the sliding-door unit.



## Sets of drawers

Sets of drawers as a complete unit consisting of top cover shelf, block sides and different drawers. If sets of drawers are stacked, the cover shelf of the bottom set of drawers is omitted and can be deducted from the price. A cover for a set of drawers must be fitted for mounting the units as stand-alone units at one side. If 2 sets of drawers are fitted adjacently please use the centre partition kit (see page 240). For fitting at any level and accessories: see pages 247-249!







Please state clearly in the order if the sets are to be fitted in a hinge-door wardrobe or in the MULTI-FORMA II room system!		for wardrobe inside widths	Type no. for hinge-door wardrobes and MULTI-FORMA II room system	Type no. for folding- and sliding-door wardrobes
	<b>Set 1</b> 1 drawer with wooden front Total height: 21.5 cm	48 cm 58 cm 68 cm 78 cm 88 cm 98 cm 108 cm	60013 60012 60018 60014 60015 60016 600166	- 610121 L 610122 R 610181 L 610182 R 610141 L 610142 R 610151 L 610152 R 610161 L 610162 R 6101661 L 6101662 R
	<b>Set 2</b> 1 drawer with glass front Total height: 21.5 cm	48 cm 58 cm 68 cm 78 cm 88 cm 98 cm 108 cm	60023 60022 60028 60024 60025 60026 600266	- 610221 L 610222 R 610281 L 610282 R 610241 L 610242 R 610251 L 610252 R 610261 L 610262 R 6102661 L 6102662 R
	<b>Set 3</b> 1 shoe drawer Total height: 40.7 cm	48 cm 58 cm 68 cm 78 cm 88 cm 98 cm 108 cm	- - 60038 60034 60035 60036 600366	- - - 610341 L 610342 R 610351 L 610352 R 610361 L 610362 R 6103661 L 6103662 R
	<b>Set 4</b> 2 drawers with wooden front Total height: 40.7 cm	48 cm 58 cm 68 cm 78 cm 88 cm 98 cm 108 cm	60043 60042 60048 60044 60045 60046 600466	- 610421 L 610422 R 610481 L 610482 R 610441 L 610442 R 610451 L 610452 R 610461 L 610462 R 6104661 L 6104662 R
	<b>Set 5</b> 1 drawer with glass front 1 drawer with wooden front Total height: 40.7 cm	48 cm 58 cm 68 cm 78 cm 88 cm 98 cm 108 cm	60053 60052 60058 60054 60055 60056 600566	- 610521 L 610522 R 610581 L 610582 R 610541 L 610542 R 610551 L 610552 R 610561 L 610562 R 6105661 L 6105662 R
	<b>Set 6</b> 2 drawers with glass front Total height: 40.7 cm	48 cm 58 cm 68 cm 78 cm 88 cm 98 cm 108 cm	60063 60062 60068 60064 60065 60066 600666	- 610621 L 610622 R 610681 L 610682 R 610641 L 610642 R 610651 L 610652 R 610661 L 610662 R 6106661 L 6106662 R

# Wardrobe interior fittings

# WARDROBE INTERIOR FITTINGS

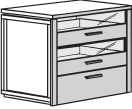
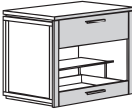

## Sets of drawers

Sets of drawers as a complete unit consisting of top cover shelf, block sides and different drawers. If sets of drawers are stacked, the cover shelf of the bottom set of drawers is omitted and can be deducted from the price. A cover for a set of drawers must be fitted for mounting the units as stand-alone units at one side. If 2 sets of drawers are fitted adjacently please use the centre partition kit (see page 240). For fitting at any level and accessories: see pages 247-249!

Please state clearly in the order if the sets are to be fitted in a hinge-door wardrobe or in the MULTI-FORMA II room system!		for wardrobe inside widths	Type no. for hinge-door wardrobes and MULTI-FORMA II room system		Type no. for folding- and sliding-door wardrobes	
	<b>Set 7</b> 3 drawers with wooden front	Total height: 59.9 cm	48 cm 58 cm 68 cm 78 cm 88 cm 98 cm 108 cm  60073 60072 60078 60074 60075 60076 60076		- - 610721 L 610722 R 610781 L 610782 R 610741 L 610742 R 610751 L 610752 R 610761 L 610762 R 6107661 L 6107662 R	-
	<b>Set 8</b> 1 drawer with glass front 2 drawers with wooden front	Total height: 59.9 cm	48 cm 58 cm 68 cm 78 cm 88 cm 98 cm 108 cm  60083 60082 60088 60084 60085 60086 60086		- - 610821 L 610822 R 610881 L 610882 R 610841 L 610842 R 610851 L 610852 R 610861 L 610862 R 6108661 L 6108662 R	-
	<b>Set 9</b> 2 drawers with glass front 1 drawer with wooden front	Total height: 59.9 cm	48 cm 58 cm 68 cm 78 cm 88 cm 98 cm 108 cm  60093 60092 60098 60094 60095 60096 60096		- - 610921 L 610922 R 610981 L 610982 R 610941 L 610942 R 610951 L 610952 R 610961 L 610962 R 6109661 L 6109662 R	-
	<b>Set 10</b> 1 drawer with wooden front 1 shoe drawer	Total height: 59.9 cm	48 cm 58 cm 68 cm 78 cm 88 cm 98 cm 108 cm  - - 60108 60104 60105 60106 60106	--	- - - - 611041 L 611042 R 611051 L 611052 R 611061 L 611062 R 6110661 L 6110662 R	---
	<b>Set 11</b> 4 drawers with wooden front	Total height: 79.1 cm	48 cm 58 cm 68 cm 78 cm 88 cm 98 cm 108 cm  60113 60112 60118 60114 60115 60116 60116		- - 611121 L 611122 R 611181 L 611182 R 611141 L 611142 R 611151 L 611152 R 611161 L 611162 R 6111661 L 6111662 R	-
	<b>Set 12</b> 1 drawer with glass front 3 drawers with wooden front	Total height: 79.1 cm	48 cm 58 cm 68 cm 78 cm 88 cm 98 cm 108 cm  60123 60122 60128 60124 60125 60126 60126		- - 611221 L 611222 R 611281 L 611282 R 611241 L 611242 R 611251 L 611252 R 611261 L 611262 R 6112661 L 6112662 R	-
	<b>Set 13</b> 2 drawers with glass front 2 drawers with wooden front	Total height: 79.1 cm	48 cm 58 cm 68 cm 78 cm 88 cm 98 cm 108 cm  60133 60132 60138 60134 60135 60136 60136		- - 611321 L 611322 R 611381 L 611382 R 611341 L 611342 R 611351 L 611352 R 611361 L 611362 R 6113661 L 6113662 R	-

## Sets of drawers

Sets of drawers as a complete unit consisting of top cover shelf, block sides and different drawers. If sets of drawers are stacked, the cover shelf of the bottom set of drawers is omitted and can be deducted from the price. A cover for a set of drawers must be fitted for mounting the units as stand-alone units at one side. If 2 sets of drawers are fitted adjacently please use the centre partition kit (see page 240). For fitting at any level and accessories: see pages 247-249!

Please state clearly in the order if the sets are to be fitted in a hinge-door wardrobe or in the MULTI-FORMA II room system!		for wardrobe inside widths	Type no. for hinge-door wardrobes and MULTI-FORMA II room system	Type no. for folding- and sliding-door wardrobes
 <p><b>Set 14</b> 5 drawers with wooden front</p>	Total height: 98.3 cm	48 cm	<b>60143</b>	-
		58 cm	<b>60142</b>	<b>611421 L</b> <b>611422 R</b>
		68 cm	<b>60148</b>	<b>611481 L</b> <b>611482 R</b>
		78 cm	<b>60144</b>	<b>611441 L</b> <b>611442 R</b>
		88 cm	<b>60145</b>	<b>611451 L</b> <b>611452 R</b>
		98 cm	<b>60146</b>	<b>611461 L</b> <b>611462 R</b>
		108 cm	<b>601466</b>	<b>6114661 L</b> <b>6114662 R</b>
 <p><b>Set 15</b> 1 drawer with glass front 4 drawers with wooden front</p>	Total height: 98.3 cm	48 cm	<b>60153</b>	-
		58 cm	<b>60152</b>	<b>611521 L</b> <b>611522 R</b>
		68 cm	<b>60158</b>	<b>611581 L</b> <b>611582 R</b>
		78 cm	<b>60154</b>	<b>611541 L</b> <b>611542 R</b>
		88 cm	<b>60155</b>	<b>611551 L</b> <b>611552 R</b>
		98 cm	<b>60156</b>	<b>611561 L</b> <b>611562 R</b>
		108 cm	<b>601566</b>	<b>6115661 L</b> <b>6115662 R</b>
 <p><b>Set 16</b> 2 drawers with glass front 3 drawers with wooden front</p>	Total height: 98.3 cm	48 cm	<b>60163</b>	-
		58 cm	<b>60162</b>	<b>611621 L</b> <b>611622 R</b>
		68 cm	<b>60168</b>	<b>611681 L</b> <b>611682 R</b>
		78 cm	<b>60164</b>	<b>611641 L</b> <b>611642 R</b>
		88 cm	<b>60165</b>	<b>611651 L</b> <b>611652 R</b>
		98 cm	<b>60166</b>	<b>611661 L</b> <b>611662 R</b>
		108 cm	<b>601666</b>	<b>6116661 L</b> <b>6116662 R</b>

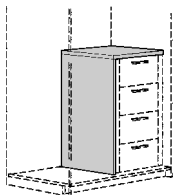

### Cover for sets of drawers

The cover for sets of drawers is necessary when sets of drawers are fitted as stand-alone units at one side in the wardrobe (example: a 48 cm wide set is fitted in a wardrobe with an inside width of 98 cm so that one side of the set is fitted on the interior side of the wardrobe and the other side of the set stands alone in the wardrobe centre).

See here page 250!

### Fitting at any level

Besides being able to fit complete sets of drawers, it is also possible to plan wardrobe interior fittings individually. All carcasses, consisting of the top cover shelf and block sides, can be fitted individually with different drawers. A cover for a set of drawers must be fitted for mounting the units as stand-alone units at one side in a wardrobe. If 2 carcasses are fitted adjacently, the centre partition kit must be used (see page 240). Complete sets of drawers: see pages 244-246! Accessories: see page 249!

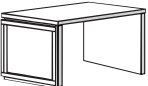
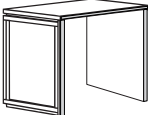
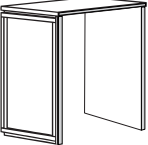
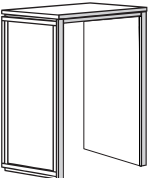
Please state clearly in the order if the carcasses are to be fitted in a hinge-door wardrobe or in the MULTI-FORMA II room system!		for wardrobe inside widths	Type no. for hinge-door wardrobes and MULTI-FORMA II room system	Type no. for folding- and sliding-door wardrobes
	<b>1 Raster carcass</b> Total height: 21.5 cm	48 cm 58 cm 68 cm 78 cm 88 cm 98 cm 108 cm	<b>40013</b> <b>40012</b> <b>40018</b> <b>40014</b> <b>40015</b> <b>40016</b> <b>400166</b>	- - <b>410121 L</b> <b>410122 R</b> <b>410181 L</b> <b>410182 R</b> <b>410141 L</b> <b>410142 R</b> <b>410151 L</b> <b>410152 R</b> <b>410161 L</b> <b>410162 R</b> <b>4101661 L</b> <b>4101662 R</b>
	<b>2 Raster carcass</b> Total height: 40.7 cm	48 cm 58 cm 68 cm 78 cm 88 cm 98 cm 108 cm	<b>40023</b> <b>40022</b> <b>40028</b> <b>40024</b> <b>40025</b> <b>40026</b> <b>400266</b>	- - <b>410221 L</b> <b>410222 R</b> <b>410281 L</b> <b>410282 R</b> <b>410241 L</b> <b>410242 R</b> <b>410251 L</b> <b>410252 R</b> <b>410261 L</b> <b>410262 R</b> <b>4102661 L</b> <b>4102662 R</b>
	<b>3 Raster carcass</b> Total height: 59.9 cm	48 cm 58 cm 68 cm 78 cm 88 cm 98 cm 108 cm	<b>40033</b> <b>40032</b> <b>40038</b> <b>40034</b> <b>40035</b> <b>40036</b> <b>400366</b>	- - <b>410321 L</b> <b>410322 R</b> <b>410381 L</b> <b>410382 R</b> <b>410341 L</b> <b>410342 R</b> <b>410351 L</b> <b>410352 R</b> <b>410361 L</b> <b>410362 R</b> <b>4103661 L</b> <b>4103662 R</b>
	<b>4 Raster carcass</b> Total height: 79.1 cm	48 cm 58 cm 68 cm 78 cm 88 cm 98 cm 108 cm	<b>40043</b> <b>40042</b> <b>40048</b> <b>40044</b> <b>40045</b> <b>40046</b> <b>400466</b>	- - <b>410421 L</b> <b>410422 R</b> <b>410481 L</b> <b>410482 R</b> <b>410441 L</b> <b>410442 R</b> <b>410451 L</b> <b>410452 R</b> <b>410461 L</b> <b>410462 R</b> <b>4104661 L</b> <b>4104662 R</b>
	<b>5 Raster carcass</b> Total height: 98.3 cm	48 cm 58 cm 68 cm 78 cm 88 cm 98 cm 108 cm	<b>40053</b> <b>40052</b> <b>40058</b> <b>40054</b> <b>40055</b> <b>40056</b> <b>400566</b>	- - <b>410521 L</b> <b>410522 R</b> <b>410581 L</b> <b>410582 R</b> <b>410541 L</b> <b>410542 R</b> <b>410551 L</b> <b>410552 R</b> <b>410561 L</b> <b>410562 R</b> <b>4105661 L</b> <b>4105662 R</b>

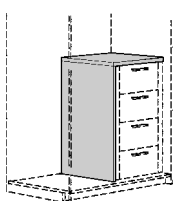

### Cover for sets of drawers

The cover for sets of drawers is necessary when carcasses are fitted as stand-alone units at one side in the wardrobe (example: a 48 cm wide carcass is fitted in a wardrobe with an inside width of 98 cm so that one side of the carcass is fitted on the interior side of the wardrobe and the other side of the carcass stands alone in the wardrobe centre).

See here page 250!

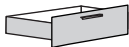
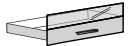
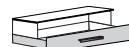

## Fitting at any level

Besides being able to fit complete sets of drawers, it is also possible to plan wardrobe interior fittings individually. All carcasses, consisting of the top cover shelf and block sides, can be fitted individually with different drawers. A cover for a set of drawers must be fitted for mounting the units as stand-alone units at one side in a wardrobe. If 2 carcasses are fitted adjacently, the centre partition kit must be used (see page 240). Complete sets of drawers: see pages 244-246! Accessories: see page 249!

		for wardrobe inside widths	Type no. for hinge-door wardrobes and MULTI-FORMA II room system		Type no. for folding- and sliding-door wardrobes		
	<b>1 Raster drawer with wooden front</b>	19.2 cm high	48 cm 58 cm 68 cm 78 cm 88 cm 98 cm 108 cm	<b>49263</b> <b>49262</b> <b>49268</b> <b>49264</b> <b>49265</b> <b>49266</b> <b>492666</b>		- <b>49263</b> <b>49268</b> <b>49264</b> <b>49265</b> <b>49266</b>	-
	<b>1 Raster drawer with glass front</b>	19.2 cm high	48 cm 58 cm 68 cm 78 cm 88 cm 98 cm 108 cm	<b>49273</b> <b>49272</b> <b>49278</b> <b>49274</b> <b>49275</b> <b>49276</b> <b>492766</b>		- <b>49273</b> <b>49272</b> <b>49278</b> <b>49274</b> <b>49275</b> <b>49276</b>	-
	<b>2 Raster shoe drawer with metal shelf; fits approx. shoe size 46</b>	38.4 cm high	48 cm 58 cm 68 cm 78 cm 88 cm 98 cm 108 cm	- - <b>49208</b> <b>49204</b> <b>49205</b> <b>49206</b> <b>492066</b>	--	- - - <b>49208</b> <b>49204</b> <b>49205</b> <b>49206</b>	---

## Accessories

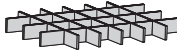
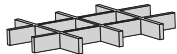
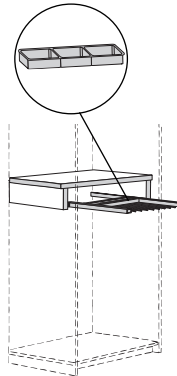
The drawers in the sets of drawers and the carcasses for fitting at any level can be fitted with drawer compartments. The pull-out trouser holder is meant for fitting on the inner side of the wardrobe. The storage bowl enhances the pull-out trouser holder in the form of an additional extra.

	for wardrobe inside widths	Type no. for hinge-door wardrobes and MULTI-FORMA II room system	Type no. for folding- and sliding-door wardrobes																											
 <p><b>Compartment for ties</b> We recommend only fitting these compartments in drawers with glass fronts. 5.6 cm high</p> <table border="1"> <thead> <tr> <th colspan="3">Number of compartments for ties:</th> </tr> <tr> <th>for wardrobe inside width:</th> <th>Hinge-doors/ room system</th> <th>Folding-doors/ sliding-doors</th> </tr> </thead> <tbody> <tr><td>48 cm</td><td>12</td><td>-</td></tr> <tr><td>58 cm</td><td>16</td><td>12</td></tr> <tr><td>68 cm</td><td>20</td><td>16</td></tr> <tr><td>78 cm</td><td>24</td><td>20</td></tr> <tr><td>88 cm</td><td>28</td><td>24</td></tr> <tr><td>98 cm</td><td>32</td><td>28</td></tr> <tr><td>108 cm</td><td>32</td><td>32</td></tr> </tbody> </table>	Number of compartments for ties:			for wardrobe inside width:	Hinge-doors/ room system	Folding-doors/ sliding-doors	48 cm	12	-	58 cm	16	12	68 cm	20	16	78 cm	24	20	88 cm	28	24	98 cm	32	28	108 cm	32	32	48 cm 58 cm 68 cm 78 cm 88 cm 98 cm 108 cm	49283 49282 49288 49284 49285 49286 492866	- 49283 49282 49288 49284 49285 49286
Number of compartments for ties:																														
for wardrobe inside width:	Hinge-doors/ room system	Folding-doors/ sliding-doors																												
48 cm	12	-																												
58 cm	16	12																												
68 cm	20	16																												
78 cm	24	20																												
88 cm	28	24																												
98 cm	32	28																												
108 cm	32	32																												
 <p><b>Compartment for linen</b> We recommend only fitting these compartments in drawers with glass fronts. 5.6 cm high</p> <table border="1"> <thead> <tr> <th colspan="3">Number of compartments for linen:</th> </tr> <tr> <th>for wardrobe inside width:</th> <th>Hinge-doors/ room system</th> <th>Folding-doors/ sliding-doors</th> </tr> </thead> <tbody> <tr><td>48 cm</td><td>6</td><td>-</td></tr> <tr><td>58 cm</td><td>9</td><td>6</td></tr> <tr><td>68 cm</td><td>12</td><td>9</td></tr> <tr><td>78 cm</td><td>15</td><td>12</td></tr> <tr><td>88 cm</td><td>15</td><td>15</td></tr> <tr><td>98 cm</td><td>15</td><td>15</td></tr> <tr><td>108 cm</td><td>15</td><td>15</td></tr> </tbody> </table>	Number of compartments for linen:			for wardrobe inside width:	Hinge-doors/ room system	Folding-doors/ sliding-doors	48 cm	6	-	58 cm	9	6	68 cm	12	9	78 cm	15	12	88 cm	15	15	98 cm	15	15	108 cm	15	15	48 cm 58 cm 68 cm 78 cm 88 cm 98 cm 108 cm	49293 49292 49298 49294 49295 49296 492966	- 49293 49292 49298 49294 49295 49296
Number of compartments for linen:																														
for wardrobe inside width:	Hinge-doors/ room system	Folding-doors/ sliding-doors																												
48 cm	6	-																												
58 cm	9	6																												
68 cm	12	9																												
78 cm	15	12																												
88 cm	15	15																												
98 cm	15	15																												
108 cm	15	15																												
 <p><b>Pull-out trouser holder</b> incl. top wooden cover shelf, block sides and storage bowl (storage bowl in 3 compartments, 2.7 cm high, 24.3 cm wide, 10.7 cm deep, of grey plastic, resting in rear area of trouser holder); for fitting on inner side of wardrobe at 98.3 cm height Total height of pull-out trouser holder including cover shelf: 21.5 cm; block 19.2 cm high, 55.0 cm deep</p> <table border="1"> <thead> <tr> <th colspan="3">Number of compartments for trousers / number of storage bowls:</th> </tr> <tr> <th>for wardrobe inside width:</th> <th>Hinge-doors/ room system</th> <th>Folding-doors/ sliding-doors</th> </tr> </thead> <tbody> <tr><td>68 cm</td><td>10 / 1</td><td>-</td></tr> <tr><td>78 cm</td><td>12 / 2</td><td>10 / 1</td></tr> <tr><td>88 cm</td><td>14 / 2</td><td>12 / 2</td></tr> <tr><td>98 cm</td><td>16 / 2</td><td>14 / 2</td></tr> <tr><td>108 cm</td><td>-</td><td>16 / 2</td></tr> </tbody> </table>	Number of compartments for trousers / number of storage bowls:			for wardrobe inside width:	Hinge-doors/ room system	Folding-doors/ sliding-doors	68 cm	10 / 1	-	78 cm	12 / 2	10 / 1	88 cm	14 / 2	12 / 2	98 cm	16 / 2	14 / 2	108 cm	-	16 / 2	68 cm 78 cm 88 cm 98 cm 108 cm	40008 40004 40005 40006 -	- - 410041 L 410042 R 410051 L 410052 R 410061 L 410062 R 4100661 L 4100662 R						
Number of compartments for trousers / number of storage bowls:																														
for wardrobe inside width:	Hinge-doors/ room system	Folding-doors/ sliding-doors																												
68 cm	10 / 1	-																												
78 cm	12 / 2	10 / 1																												
88 cm	14 / 2	12 / 2																												
98 cm	16 / 2	14 / 2																												
108 cm	-	16 / 2																												
<p>If the cover shelf is fitted in the MULTI-FORMA II room system, please add a "1" to the type number (e.g. 492531). Please state clearly in the order!</p>  <p><b>Cover shelf</b> 2.3 cm thick</p>	48 cm 58 cm 68 cm 78 cm 88 cm 98 cm 108 cm	49253 49252 49258 49254 49255 49256 492566	49253 49252 49258 49254 49255 49256 492566																											

## Cover for sets of drawers

(stand-alone at one side); consisting of block sides and a top cover shelf. The cover for sets of drawers is necessary when sets of drawers and carcasses are fitted as stand-alone units at one side in the wardrobe (example: a 48 cm wide set is fitted in a wardrobe with an inside width of 98 cm so that one side of the set is fitted on the interior side of the wardrobe and the other side of the set stands alone in the wardrobe centre). Note: The standard cover shelf of the sets of drawers or carcasses is automatically removed from the set or carcass. The cost of the special cover for the set of drawers or carcasses is offset against the cost of this standard cover.

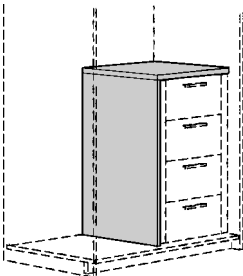
If the cover for sets of drawers is to be fitted in the MULTI-FORMA II room system, please add a "1" to the type number (e.g. 404131). Please state clearly in the order!		for wardrobe inside widths	Type no. for hinge-door wardrobes and MULTI-FORMA II room system	Type no. for folding- and sliding-door wardrobes
 <p>Cover for sets of drawers</p>	for 1 Raster height	48 cm 58 cm 68 cm 78 cm 88 cm 98 cm 108 cm	40413 40412 40418 40414 40415 40416 404166	40413 40412 40418 40414 40415 40416 404166
	for 2 Raster height	48 cm 58 cm 68 cm 78 cm 88 cm 98 cm 108 cm	40423 40422 40428 40424 40425 40426 404266	40423 40422 40428 40424 40425 40426 404266
	for 3 Raster height	48 cm 58 cm 68 cm 78 cm 88 cm 98 cm 108 cm	40433 40432 40438 40434 40435 40436 404366	40433 40432 40438 40434 40435 40436 404366
	for 4 Raster height	48 cm 58 cm 68 cm 78 cm 88 cm 98 cm 108 cm	40443 40442 40448 40444 40445 40446 404466	40443 40442 40448 40444 40445 40446 404466
	for 5 Raster height	48 cm 58 cm 68 cm 78 cm 88 cm 98 cm 108 cm	40453 40452 40458 40454 40455 40456 404566	40453 40452 40458 40454 40455 40456 404566

## Wardrobe interior fittings in special width

In order to exploit the area available inside the wardrobes in special width optimally, it is also possible to order the wardrobe interior fittings in special width for these units.

**Cover shelf and side panels in special width** type 99911  
**See below for two examples of calculation!**

### Hinge-door wardrobes and MULTI-FORMA II room system

The standard sets of drawers and carcasses for fitting at any level in hinge-door wardrobes and in the MULTI-FORMA II room system have slim 4.5 cm wide side panels fitted at both sides (see here pages 242-243). These panel sizes are different in the case of wardrobe interior fittings in special width.

If a hinge-door wardrobe, for example, is required in the special wardrobe inside width of 64 cm, the wardrobe interior fittings must be fitted in the next smaller standard size – that means the required wardrobe interior fittings are in a width of 58 cm. The difference in width of 6 cm that results is balanced out by making the 4.5 cm wide side panels 3 cm wider (= 7.5 cm each).

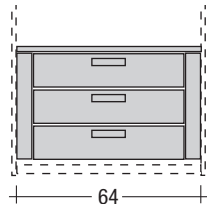

Special wardrobe inside width of 64 cm

64

Standard width of wardrobe interior fittings of 58 cm

58

The panel width now comes to 7.5 cm each

3 4,5	4,5 3
+++	+++
7,5	7,5

### Folding-door and sliding-door wardrobes

The standard sets of drawers and carcasses for fitting at any level in folding- and sliding-door wardrobes are fitted with a slim 4.5 cm wide side panel at one side and a wide 14.5 cm wide side panel at the other side (see here pages 242-243). The panel size of the slim panel is different in the case of wardrobe interior fittings in special width.

If a folding-door wardrobe, for example, is required in the special wardrobe inside width of 82 cm, the wardrobe interior fittings must be fitted in the next smaller standard size – that means the required wardrobe interior fittings are in a width of 78 cm. The difference in width of 4 cm that results is balanced out by making the 4.5 cm wide side panel 4 cm wider (= 8.5 cm), the 14.5 cm wide side panel always retains its original width.

**L/R = left/right (see here pages 242-243)**

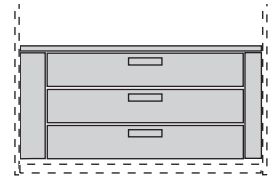

Special wardrobe inside width of 82 cm

82

Standard width of wardrobe interior fittings of 78 cm

78

Large side panel width always remains in original size of 14.5 cm, the slim side panel width is now 8.5 cm

+++	4,5 4
14,5	+++
	8,5



# Usable bed inside height and space under bed

## Note on usable bed inside height:

The support slats of the hülsta beds are delivered in the centre position, i.e. they can be adjusted by 3.2 cm upwards and downwards (exception: for LUNIS beds in the standard surface height 1 only by 3.2 cm upwards. If the slats are set in the lowest position, the **maximum usable bed inside height** is achieved.

In the case of some beds, especially the design-oriented beds, the bed inside height is comparatively low. This means that mattresses in combination with base frames that are somewhat higher (e.g. base frames with motor drive) are not held so well by the bed side sections. Please note that the usable bed inside height of beds with height adjustable support slats is reduced when these are set higher.

This is how to calculate the individual height from the data supplied with the base frames:

**Example (for all beds): ELUMO II bed and hülstaflex basic B base frame (back and foot sections adjustable)**

**Max. usable bed inside height:**  
18.0 cm

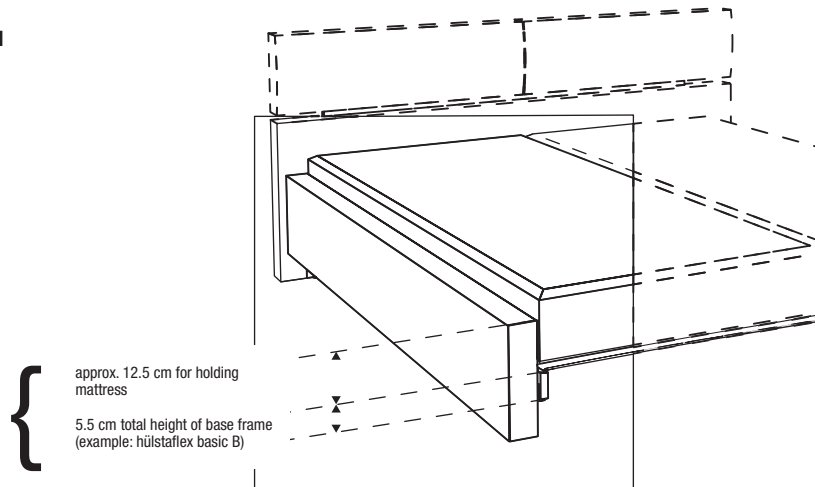

**LUNIS bed in standard surface height 1 and hülstaflex basic B base frame (back and foot sections adjustable)**

**Max. usable bed inside height:**  
14.0 cm

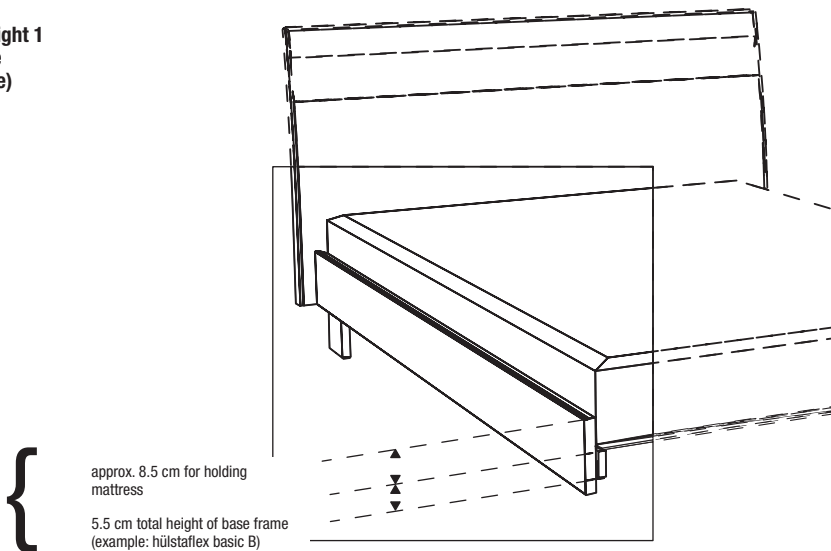

## Note on space under bed:

The storage space underneath the base frame is calculated from the bed height minus the usable bed inside height.

Example ELUMO II bed: **42.2 cm - 18.0 cm = 24.2 cm.**

A space of 15 cm below the bed is necessary for hülsta base frames with motor drives. This is guaranteed in nearly all hülsta beds. With hülstaflex premium Motor the motor lies above the support slats: greatest amount of space possible.

# SPECIAL WISHES? COME TO US!

---

**Maximum individuality!**  
**Maximal flexibility!**  
**hülsta makes most of your special wishes possible.**

High-quality furnishing is an expression of your individuality and personality.

hülsta has perfected this idea. We have developed some innovative production systems, which can fulfil more special wishes than ever before. And it makes no difference what range you are thinking of. We will try everything to put your ideas into practice.

There are already a lot of special products available for ordering from the hülsta type lists to make things as easy for you as possible.

And if you do have a wish which is not quite so easy to implement, just give us a call or send us a mail or a fax. We have our own hülsta "Special Wishes Team" who are there to help you realise just these customer requests.

These colleagues are professionals when it comes to special products. They plan and calculate the possible products for you and even develop an alternative suggestion if the idea should turn out to be technically impossible.

## **Here is an overview of the hülsta range of special wishes:**

- A lot of special products can simply be ordered via the type lists
- Special products are planned simply and professionally
- Competent colleagues advise you by phone, by fax and by mail
- You will be sent alternative suggestions if the idea is technically impossible
- Many special products are available without a surcharge
- Specially qualified carpenters and technicians implement your plans perfectly

Something missing? Then simply contact us. Our "Special Wishes Team" can make almost anything possible. And if you should happen to present us with an impossible case – no problem. You will be sent a good alternative suggestion which is sure to work.

CONTACT US:  
Tel.: +49 (0) 2563 / 86-0  
Fax: +49 (0) 2563 / 86-1417  
Mail: sonderwunsch@huelsta.com  
Mon. - Sat.: 9.00 until 18.00

## Special heights, special widths, special depths

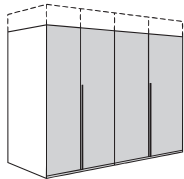

### Special heights

Hinge-, folding- and sliding-door wardrobes can be reduced in height at intervals of 1.0 cm.

Special heights in stepped versions (not possible on sliding-door wardrobes) at a surcharge: surcharge per step:

Below eye-level we recommend fitting a top cover shelf made of panelling material. Please state in order!

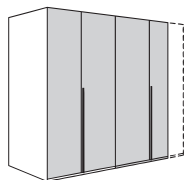

### Special widths

Only applies to hinge- and folding-door wardrobes.

Single-door units, left or right hinges, can be reduced down to 25 cm width (apart from profiled doors).

Twin-door units can be reduced at both sides down to 50 cm total width (apart from profiled doors).

Interior fittings, such as drawers and other fittings cannot be reduced in width.

For notes on width reductions on MULTI-FORMA II sliding-door wardrobes please see special-sized products for MULTI-FORMA II!

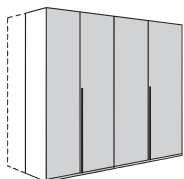

### Special depths

Depth reductions are made on side sections, plinths, cornices and shelves.

Interior fittings, such as drawers and other fittings cannot be reduced in depth.

A max. reduction of 30.0 cm is possible on hinge- and folding-door wardrobes.

A max. reduction of 9.0 cm is possible on profiled hinge-doors.

For sliding-door wardrobes, a max. reduction of 30.0 cm is possible (max. 18 cm in combination with the electrical opening system for MULTI-FORMA II).

Please note that for technical production reasons not every special depth can be achieved:

2.5 cm standard reduction between 0 and 2.5 cm

5.0 cm standard reduction between 4.5 and 5.0 cm

27.5 cm standard reduction between 27.0 and 27.5 cm

# Side and rear sloping

## Notes on calculating sizes of sloping units

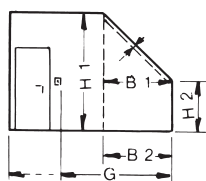
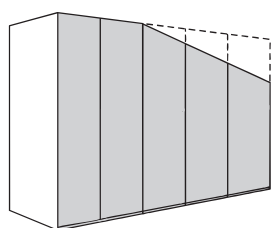

### Side sloping

Sloping is only possible on single-door units. The door hinge (left or right) is positioned on the taller outer side of the unit.

#### Measurements required:

- H 1 = Room height
- H 2 = Height of slope  
(If a space is required between the wall and the wardrobe/unit, please state the exact distance.)
- B 1 = Width of slope
- B 2 = Width of slope
- G = Total width
- S = Wardrobe width

#### Please note!

- If the slope cuts across the position of a handle, the handle of this door only is positioned further down in production.
- As floors, ceilings and walls are never exactly straight, the exact room size must be measured using a spirit level.
- If a cornice is fitted, please state if this is to be continued in the sloping section.
- For CUTARO and ELUMO II wardrobes with a passepartout section, the passepartout for the complete wardrobe is set back by 2 cm (no forward protruding any more).

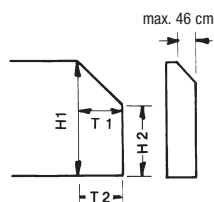
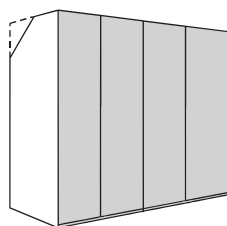

### Rear sloping

Rear sloping is possible on all wardrobe units.

#### Measurements required:

- H 1 = Room height
- H 2 = Height of slope  
(If a space is required between the wall and the wardrobe/unit, please state the exact distance.)
- T 1 = Depth of slope
- T 2 = Depth of slope

## CUTARO

### Wardrobes

#### Special heights:

Hinge-door	- Wood	0003	no surcharge
Hinge-door	- Mirror	00031	no surcharge

#### Special widths (not possible on high-gloss fronts):

for single-door unit	- Wood	0005
for single-door unit	- Mirror	00051
for twin-door unit	- Wood	0006
for twin-door unit	- Mirror	00061

When ordering extra fitted shelves and clothes rods

Size reduction surcharge per fitted shelf	9991
Size reduction surcharge per clothes rod	9992

#### Special depths:

Surcharge per unit	0007
--------------------	------

When ordering extra fitted shelves

Size reduction surcharge per fitted shelf	9993
---	------

#### Side sloping:

Surcharge per unit without passepartout in the slope	9994
--	------

Surcharge per unit with passepartout in the slope	99916
---	-------

#### Rear sloping:

Surcharge per unit	99912
--------------------	-------

### Ancillary units

**Special heights** (doors with design fractal and drawers not possible in special height):

Carcase	99902
Door	99903
Chest of drawers in drawer raster	99902

**Special widths** (drawers with design fractal not possible in special width):

Carcase	999120
Door	999130
Drawer	999170

When ordering extra fitted shelves

Size reduction surcharge per fitted shelf	999141
---	--------

### Beds

Bed in special length 190 cm	99964
------------------------------	-------

Bed with two footboards (all-round bed; not possible on beds with bed surround frame of leather)	99967	no surcharge
--	-------	--------------

#### Special-sized products for special combinations:

Pricing: recommended retail price of the special combination + 15% plus the recommended retail prices of all the required special-sized products (see above)

**More special products are possible.**

**Please get in touch with your customer advisor.**

## ELUMO II

### Wardrobes

#### Special heights:

Hinge-door	- Wood	0003	no surcharge
Hinge-door	- Mirror	00031	no surcharge

**Special widths** (not possible for doors with artificial leather or genuine leather application or on intermediate units):

for single-door unit	- Wood	0005
for single-door unit	- Mirror	00051
for twin-door unit	- Wood	0006
for twin-door unit	- Mirror	00061

When ordering extra fitted shelves and clothes rods

Size reduction surcharge per fitted shelf	9991
Size reduction surcharge per clothes rod	9992

**Special depths** (not possible on intermediate units with open compartment in artificial leather or genuine leather):

Surcharge per unit	0007
--------------------	------

When ordering extra fitted shelves

Size reduction surcharge per fitted shelf	9993
---	------

Intermediate unit

Depth reduced by 12 cm	
Depth reduced by 24 cm	

#### Side sloping:

Surcharge per unit without passepartout in the slope	9994
--	------

Surcharge per unit with passepartout in the slope	99916
---	-------

#### Rear sloping:

Surcharge per unit	99912
--------------------	-------

### Ancillary units

**Special heights** (drawers not possible in special height):

Carcase	99902
Door	99903

**Special widths** (not possible with integrated niche lamps, on ancillary units with open compartment in artificial leather or genuine leather or on 80 cm wide consoles and chests; width reduction on 120 cm wide chests with open compartment: max. 40 cm):

Carcase	999120
Door	999130
Drawer	999140
Wall shelf (min. 36 cm wide)	999753

When ordering extra fitted shelves

Size reduction surcharge per fitted shelf	999141
---	--------

### Beds

Bed in special length 190 cm	99964
------------------------------	-------

Upholstered headboard in special height	99965
---	-------

#### Special-sized products for special combinations:

Pricing: recommended retail price of the special combination + 15% plus the recommended retail prices of all the required special-sized products (see above)

**More special products are possible.**

**Please get in touch with your customer advisor.**

## FENA

### Wardrobes

#### Special heights:

Hinge-door	- Wood	<b>0003</b>	no surcharge
Hinge-door	- Mirror	<b>00031</b>	no surcharge

#### Special widths:

for single-door unit	- Wood	<b>0005</b>
for single-door unit	- Mirror	<b>00051</b>
for twin-door unit	- Wood	<b>0006</b>
for twin-door unit	- Mirror	<b>00061</b>

When ordering extra fitted shelves and clothes rods

Size reduction surcharge per fitted shelf	<b>9991</b>
Size reduction surcharge per clothes rod	<b>9992</b>

#### Special depths:

Surcharge per unit	<b>0007</b>
--------------------	-------------

When ordering extra fitted shelves

Size reduction surcharge per fitted shelf	<b>9993</b>
---	-------------

#### Side sloping:

Surcharge per unit	<b>9994</b>
--------------------	-------------

#### Rear sloping:

Surcharge per unit	<b>99912</b>
--------------------	--------------

### Beds

Bed in special length 190 cm	<b>99964</b>	
Bed with two footboards (all-round bed)	<b>99967</b>	no surcharge

#### Special-sized products for special combinations:

Pricing: recommended retail price of the special combination + 15% plus the recommended retail prices of all the required special-sized products (see above)

**More special products are possible.**

**Please get in touch with your customer advisor.**

## GENTIS

### Wardrobes

#### Special heights:

Hinge-door	- Wood	<b>0003</b>	no surcharge
Hinge-door	- Mirror	<b>00031</b>	no surcharge

#### Special widths:

for single-door unit	- Wood	<b>0005</b>
for single-door unit	- Mirror	<b>00051</b>
for twin-door unit	- Wood	<b>0006</b>
for twin-door unit	- Mirror	<b>00061</b>

When ordering extra fitted shelves and clothes rods

Size reduction surcharge per fitted shelf	<b>9991</b>
Size reduction surcharge per clothes rod	<b>9992</b>

#### Special depths:

Surcharge per unit	<b>0007</b>
--------------------	-------------

When ordering extra fitted shelves

Size reduction surcharge per fitted shelf	<b>9993</b>
---	-------------

#### Side sloping:

Surcharge per unit	<b>9994</b>
--------------------	-------------

#### Rear sloping:

Surcharge per unit	<b>99912</b>
--------------------	--------------

#### Special-sized products for special combinations:

Pricing: recommended retail price of the special combination + 15% plus the recommended retail prices of all the required special-sized products (see above)

**More special products are possible.**

**Please get in touch with your customer advisor.**

## LA VELA II

### Wardrobes

#### Special heights:

Hinge-/folding-door wing	- Wood	0003	no surcharge
Hinge-/folding-door wing	- Mirror	00031	no surcharge

#### Special widths (not possible on high-gloss fronts):

for single-door unit	- Wood	0005
for single-door unit	- Mirror	00051
for twin-door unit	- Wood	0006
for twin-door unit	- Mirror	00061
for panorama unit	- Wood	00062
for panorama unit	- Mirror	00063

When ordering extra fitted shelves and clothes rods

Size reduction surcharge per fitted shelf	9991
Size reduction surcharge per clothes rod	9992

#### Special depths:

Surcharge per unit	0007
--------------------	------

When ordering extra fitted shelves

Size reduction surcharge per fitted shelf	9993
---	------

Intermediate unit

Depth reduced by 12 cm	00071012
Depth reduced by 24 cm	00071024

#### Side sloping:

Surcharge per unit without cornice in the slope	9994
Surcharge per unit with cornice in the slope	99916

#### Rear sloping:

Surcharge per unit	99912
--------------------	-------

### Ancillary units

#### Special heights (drawers not possible in special height):

Carcase	99902
Door	99903
Cover panel	99900
Utility chest in drawer raster	99902

Profiled glass doors not possible in special height.

#### Special widths (the sides of veneer versions are not curved, straight rim; please state from which side the reduction should begin):

Carcase	999120
Door	999130
Drawer	999171
Cover panel	99925
Flap	999180
Wall shelf (min. 36 cm wide)	999753

When ordering extra fitted shelves

Size reduction surcharge per fitted shelf	999141
---	--------

#### Special depths (drawers not possible in special depth):

Carcase	99932
---------	-------

When ordering extra fitted shelves

Size reduction surcharge per fitted shelf	999341
---	--------

### Beds

Headboard in special width without alteration

to inside bed size (max. 3.5 cm each side)	99961
--	-------

Headboard in special height	99965
-----------------------------	-------

Bed with two footboards up to 2 m length (all-round bed; not possible for hovering beds)	99967	no surcharge
--	-------	--------------

#### Special-sized products for special combinations:

Pricing: recommended retail price of the special combination + 15% plus the recommended retail prices of all the required special-sized products (see above)

More special products are possible.

Please get in touch with your customer advisor.

## LUNIS

### Wardrobes

#### Special heights:

Hinge-door	- Wood	0003	no surcharge
Hinge-door	- Mirror	00031	no surcharge

#### Special widths:

for single-door unit	- Wood	0005
for single-door unit	- Mirror	00051
for twin-door unit	- Wood	0006
for twin-door unit	- Mirror	00061

When ordering extra fitted shelves and clothes rods

Size reduction surcharge per fitted shelf	9991
Size reduction surcharge per clothes rod	9992

#### Special depths:

Surcharge per unit	0007
When ordering extra fitted shelves	

Size reduction surcharge per fitted shelf	9993
---	------

#### Side sloping:

Surcharge per unit without cornice profile in the slope	9994
Surcharge per unit with cornice profile in the slope	99916

Side sloping is possible up to a minimum height of 88.0 cm.

#### Rear sloping:

Surcharge per unit	99912
--------------------	-------

### Ancillary units

#### Special heights (drawers not possible in special height and not possible on high-gloss versions)

Carcase	99902
Door	99903
Chest of drawers in drawer raster	99902

#### Special widths (not possible on high-gloss versions):

Carcase	999120
Door	999130
Drawer	999170
Pedestal	99930
Headboard panel	99925

When ordering extra fitted shelves

Size reduction surcharge per fitted shelf	999141
---	--------

Special widths are not possible on panel carcase and on angled shelves (for headboard panels).

#### Special depths (drawers not possible in special depth):

Carcase	99932
---------	-------

When ordering extra fitted shelves

Size reduction surcharge per fitted shelf	999341
---	--------

### Beds

Bed in special length 190 cm	99964
------------------------------	-------

Upholstered headboard in special height	99965
---	-------

Bed with two footboards (all-round bed)	99967
---	-------

Special width and height are not possible on the profiled wood/lacquer headboard.

#### Special-sized products for special combinations:

Pricing: recommended retail price of the special combination + 15% plus the recommended retail prices of all the required special-sized products (see above)

More special products are possible.

Please get in touch with your customer advisor.

## METIS plus

### Wardrobes

#### Special heights:

Hinge-/folding-door	- High-gloss	0003	no surcharge
Hinge-/folding-door	- Mirror	00031	no surcharge
Sliding-door	- High-gloss	0004	
Sliding-door	- Mirror	00041	

#### Special widths (not possible on hinge-/folding-doors):

Sliding-door	- High-gloss	00064
Sliding-door	- Mirror	00065

When ordering extra fitted shelves and clothes rods

Size reduction surcharge per fitted shelf	9991
Size reduction surcharge per clothes rod	9992

Width reductions of sliding-door wardrobes: **minimum widths**

2-door sliding-door wardrobe (all widths):  
reducible down to min. 152.0 cm width  
(please note the next smaller width!)

**Note:** If sliding-door wardrobes are required in a special width, the width of all the doors is reduced symmetrically.

Special widths are not possible on intermediate units and on hinge-/folding-door wardrobes

#### Special depths:

Surcharge per unit	0007
--------------------	------

When ordering extra fitted shelves

Size reduction surcharge per fitted shelf	9993
---	------

Intermediate units

Depth reduced by 12 cm  
Depth reduced by 24 cm

#### Side sloping:

Surcharge per unit	9994
--------------------	------

#### Rear sloping:

Surcharge per unit	99912
--------------------	-------

#### Other:

Twin-door sliding-door wardrobes are also available in reverse order (left door runs in front, right door behind). Please add an -S to the type no. in this case (e.g. 2421-S)

no surcharge

### Ancillary units

#### Special heights (drawers not possible in special height):

Carcase high-gloss	999021
Door high-gloss	999031
Chest of drawers in drawer raster	
Carcase high-gloss	999021

### Beds

(only on beds in high-gloss version;  
not possible on upholstered beds)

Headboard in special height (reduced in cm steps up to a max. 15 cm)	99965
Bed in special length 190 cm	99964
Bed in special width	99969
Bed with two footboards (all-round bed; only possible for 200 cm length)	99967

Price deduction

Special sizes are not possible on upholstered beds.

#### Special-sized products for special combinations:

Pricing: recommended retail price of the special combination + 15% plus the recommended retail prices of all the required special-sized products (see above)

**More special products are possible.**

**Please get in touch with your customer advisor.**



## MULTI-FORMA II

### Special heights:

Hinge-/folding-door	- Wood/high-gloss	<b>0003</b>	no surcharge
Hinge-/folding-door	- Mirror	<b>00031</b>	no surcharge
Sliding-door	- Wood/high-gloss	<b>0004</b>	no surcharge
Sliding-door	- Mirror	<b>00041</b>	no surcharge

### Special widths:

for single-door unit	- Wood/high-gloss	<b>0005</b>	no surcharge
for single-door unit	- Mirror	<b>00051</b>	no surcharge
for twin-door unit	- Wood/high-gloss	<b>0006</b>	no surcharge
for twin-door unit	- Mirror	<b>00061</b>	no surcharge
for panorama unit	- Wood/high-gloss	<b>00062</b>	no surcharge
for panorama unit	- Mirror	<b>00063</b>	no surcharge
Sliding-door	- Wood/high-gloss	<b>00064</b>	no surcharge
Sliding-door	- Mirror	<b>00065</b>	no surcharge

Special widths are not possible on profiled hinge-door end units, on intermediate units and on hinge-/folding-door wardrobes with doors with high-gloss fronts in design A, G, J and F.

When ordering extra fitted shelves and clothes rods			
Size reduction per fitted shelf	<b>9991</b>	no surcharge	
Size reduction per clothes rod	<b>9992</b>	no surcharge	

### Width reductions of sliding-door wardrobes: **minimum widths**

2-door sliding-door wardrobe (all widths):  
reducible down to min. 152.0 cm width  
(please note the next smaller width!)  
3-door sliding-door wardrobe (width 242 cm):  
reducible down to min. 227.0 cm width  
3-door sliding-door wardrobe (widths 272, 302 and 332 cm):  
reducible down to min. 243.0 cm width  
(please note the next smaller width!)  
4-door sliding-door wardrobe (all widths):  
reducible down to min. 302.0 cm width  
(please note the next smaller width!)

**Note:** If sliding-door wardrobes are required in a special width, the width of all the doors is reduced symmetrically.

### Special depths:

per unit	<b>0007</b>	no surcharge
----------	-------------	--------------

When ordering extra fitted shelves		
Size reduction per fitted shelf	<b>9993</b>	no surcharge

Intermediate units (not possible on intermediate units 1, 10, 4 and 11)  
Depth reduced by 12 cm  
Depth reduced by 24 cm

### Side sloping:

Surcharge per unit without cornice profile in the slope		
Design A	<b>99941</b>	
Design A plus	<b>99946</b>	
Design G	<b>99943</b>	
Design G plus	<b>99947</b>	
Design L	<b>99944</b>	
Design F	<b>99942</b>	
Design F plus	<b>99948</b>	

Surcharge per unit with cornice profile in the slope		
Design A	<b>999161</b>	
Design A plus	<b>999166</b>	
Design G	<b>999163</b>	
Design G plus	<b>999167</b>	
Design L	<b>999164</b>	
Design F	<b>999162</b>	
Design F plus	<b>999168</b>	

Carcase room system	<b>99949</b>	
---------------------	--------------	--

Side sloping of profiled hinge-door end units and of doors in Design J are not possible.

### Rear sloping:

Surcharge per unit	<b>99912</b>	
--------------------	--------------	--

Rear sloping of profiled hinge-door end units on request.

### Other:

Horizontal passepartout in high-gloss version only available in combination with a vertical passepartout.

Twin-door sliding-door wardrobes are also available in reverse order (left door runs in front, right door behind).

Please add an -S to the type no. in this case (e.g. **A55162-S**)

no surcharge

Hinge-door units in widths of 42/40, 52/50, 72/70, 82/80 and 102/100 cm and in heights of 229.6 and 268.0 cm can also be fitted with **rod handle locks** against a surcharge (exception: rod handle locks not possible on hinge-doors in Design J, F and F plus).

### Surcharge for rod handle lock per hinge-door:

for single-door hinge-door unit,	
left hinge	<b>901</b>
for single-door hinge-door unit,	
right hinge	<b>902</b>
for twin-door hinge-door unit	<b>903</b>

### Bottom end slat:

If hinge-door units are fitted with rod handle locks, a bottom end slat must be planned. In this case, the total height of an optional wardrobe interior fitting is then increased by 3.2 cm.

for wardrobe inside width 48 cm	<b>79243</b>
for wardrobe inside width 58 cm	<b>79242</b>
for wardrobe inside width 68 cm	<b>79248</b>
for wardrobe inside width 78 cm	<b>79244</b>
for wardrobe inside width 98 cm	<b>79246</b>

**More special products are possible.  
Please get in touch with your customer advisor.**

## MULTI-VARIS

### Ancillary units

#### Special heights (drawers not possible in special height):

Carcase wood/lacquer	<b>99902</b>
Carcase high-gloss	<b>999021</b>
Door wood/lacquer	<b>99903</b>
Door high-gloss	<b>999031</b>

**More special products are possible.  
Please get in touch with your customer advisor.**

## SERA

**No special-sized products are possible in the SERA range.**

# Special-sized products

---

## Special articles

---

Wardrobe doors are also available as separate units and are charged as follows:

**a) For 1 hinge-door/folding-door wing:** 50% of the concerning 1-door hinge-door extension unit

**b) For 1 sliding-door including mechanism:** 35% of the twin-door sliding-door wardrobe

For door superstructures, type **100** (max. 98 cm wide, only for assembly between wardrobes):  
100% of twin-door hinge-door extension unit

**Panels** for side and top covering of fitted wardrobes (not possible for high-gloss versions;  
support construction and fitting materials must be acquired on site).

**a) for veneered/lacquered versions** (max. 268.0 cm long, max. 61.6 cm wide, 2.0 cm thick)

Basis charge per order: **9901**

+ price per sq. m. - lacquer **990**

+ price per sq. m. - veneer **990**

Veneer match with fronts can not be guaranteed.

**Edge veneer** for veneered/lacquered versions per m. length **9902**

Wardrobe doors can also be fitted with **165° hinges** against a surcharge  
(only possible on plain, straight hinge-doors).  
Please mark the doors clearly in the order!

Surcharge for 165° hinges per hinge-door: **180**

### High-gloss care set

Polish, polishing sponge and polishing cloth (incl. instructions)  
for protecting and maintaining the high-gloss surfaces

**36**

### Special colours

All the hülsta lacquer colours are possible for nearly all the hülsta ranges.  
Availability and prices on request.

# Wall composition / assembly instruction

## Important notes:

The composition of walls must be ascertained before concluding a contract and be checked by a qualified fitter before assembly takes place.







Assembly may only be carried out by a qualified fitter under careful observation of the assembly instructions.

The plastic Rawl plugs with the type name SX 8 x 65 from the Fischer Company supplied by hülsta as a standard set are only suitable for concrete  $\geq$  C12/15, if the wall composition and compression strength corresponds to the table below. Under no circumstances must a unit be assembled on light masonry.

Furthermore, we provide a mounting set with assembly mortar from the Fischer Company for the types of walls listed below (see assembly mortar set below). Again, assembly must be carried out by a qualified fitter under careful observation of the wall composition and assembly instruction. The compression strength levels stated below must be met under all circumstances.

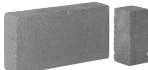
## Materials table

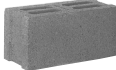
with a description of which sets are to be used with the following types of walls:

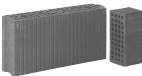
Standard set (SX 8 x 65)	Assembly mortar set only suitable for the materials stated below!	
Concrete C12/15 Compression strength $\geq$ 15 N/mm <sup>2</sup> 	 Building bricks Mz 12 Compression strength $\geq$ 12 N/mm <sup>2</sup>	 Solid blocks of light concrete V2 Compression strength $\geq$ 2 N/mm <sup>2</sup>
	 Limestone blocks KS 12 Compression strength $\geq$ 12 N/mm <sup>2</sup>	 Perforated blocks of light concrete Hbl 2 Compression strength $\geq$ 2 N/mm <sup>2</sup>
	 Perforated sand lime bricks KSL12 Compression strength $\geq$ 12 N/mm <sup>2</sup>	 Aerated concrete PP2 Compression strength $\geq$ 2 N/mm <sup>2</sup>
	 Vertically perforated bricks HLz 12 Compression strength $\geq$ 12 N/mm <sup>2</sup> Bulk density $\geq$ 1.0 kg/dm <sup>3</sup>	

A different and more suitable type of mounting must be chosen by a qualified fitter in all other cases. hülsta cannot accept any responsibility for the choice of any other types of mounting!

Please note that if the units are not mounted properly on the wall, there is a risk of the units falling down or tipping over – especially when alternative mounting materials acquired on site have been used.

Generally speaking, you as a dealer/qualified fitter are responsible for the correct wall mounting of the units.



## Mounting sets

### Labelling in type list drawings / assembly notes for wall units

The majority of units have two wall mounting points (= number of support boards), if these are to be fitted as wall units. This is not explicitly mentioned in the type list. If a different number of wall mounting points (= support boards) is required, this is marked in the drawings in the type list with numbers in black boxes. Every support board requires four mounting screws.

**3** = 3 support boards

**4** = 4 support boards, etc.

One **assembly mortar set** is sufficient for up to a maximum of 3 support boards or 4 wall side-panels.

**Important note:** Depending on the composition of the wall (see wall types illustrated above), assembly must be carried out using the special assembly mortar set and a standard trade mastic tool which are the basic essentials for safe and clean workmanship.

### Standard set

The standard set consists of 4 plastic Rawl plugs (SX 8 x 65) and 4 mounting screws and is sufficient for 1 support board. The standard sets are included in the packet of fittings to match the number of support boards.

### Assembly mortar set for up to a maximum of 3 support boards consisting of:

- 9x injection retaining sleeve
- 9x screw-in sleeve
- 1x injection cartridge
- 2x static mixer
- 1x assembly instructions

Please use the mounting screws from the standard set (supplied free of charge).

### Example of order:

- Add up number of support boards for all existing unit types
  - Divide the sum by "3"
  - Round up the result to a full number
- = Number of assembly mortar sets required

**M2**

# Switch options for lamps: Magic-Tronic

## Magic-Tronic

The lamps are normally operated by an external footswitch. As an alternative we can also provide a Magic-Tronic switch, which is charged extra. By "stroking" the outer or top side of the unit at the same level as the invisible integrated sensor it is possible to switch all the lamps on and off ("Stroking method"). As an alternative the position of the hidden sensor can also be marked with a small metal plate on the furniture unit ("Marking method"). Lamps with a maximum power of 200 W can be operated by a Magic-Tronic unit (230 V). The footswitch is omitted when a Magic-Tronic unit is included.

### Standard position of Magic-Tronic for angled shelves:

- for angled shelves of the CUTARO and METIS plus ranges: sensor is fitted **8 cm from the top rim and 8 cm from the left side in the rear wall panel**
- for angled shelves of the LUNIS range: sensor is fitted **16 cm from the rear rim and 9.6 cm from the left side in the shelf**

### Standard position of Magic-Tronic for consoles and chests:

- for consoles and chests of the ELUMO II and LUNIS ranges: sensor is fitted **16 cm from the rear rim in the cover shelf and 15.0 cm at the side next to the bed**
- for consoles and chests of the MULTI-VARIS range: sensor is fitted **12 cm from the rear rim in the outer side next to the bed and in approx. 7-15 cm from the top rim of the unit**

### Standard position of Magic-Tronic for MULTI-FORMA II wardrobes:

- for hinge- and folding-door wardrobes of the MULTI-FORMA II range: sensor is fitted **in the right passepartout in approx. 130 cm height** (Magic-Tronic is not possible for wardrobes without passepartout, in sliding-door wardrobes and in the room and niche system)

### Alternative positions:

If the Magic-Tronic sensor is to be fitted **on the right in the rear wall panel or in the shelf of angled shelves**, in the **left passepartout of the wardrobe** or **at any position other than that stated as standard** (e.g., if a unit is planned in a niche so that there is insufficient space to the right of the unit), **please state this clearly in the order and mark the position in the sketch. If in doubt, please contact your hülsta customer advisor!**

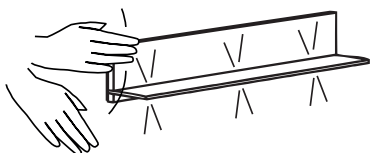

Illustration 1: "Stroking method"

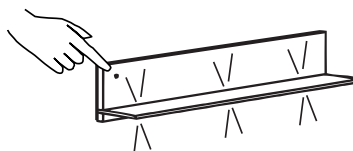

Illustration 2: "Marking method"

Magic-Tronic

7617

# Switch options for lamps: Magic-Tronic

## Examples of use (schematic diagrams)

### Example 1

Black point = Standard position of Magic-Tronic sensor for angled shelves

**Notes:**

The black point in the drawings is the area where the Magic-Tronic sensor is invisibly integrated. If the surface is „stroked“ at this position, the lamps are switched on or off.

If you would like to mark the position of the Magic-Tronic sensor on the furniture, you can fit a small metal plate supplied separately at the corresponding position.

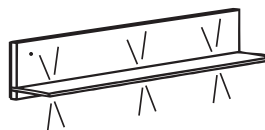

for angled shelves of the CUTARO and METIS plus ranges

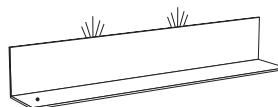

for angled shelves of the LUNIS range

### Example 2

Black point = Standard position of Magic-Tronic sensor for consoles and chests

**Notes:**

The black point in the drawings is the area where the Magic-Tronic sensor is invisibly integrated. If the surface is „stroked“ at this position, the lamps are switched on or off.

If you would like to mark the position of the Magic-Tronic sensor on the furniture, you can fit a small metal plate supplied separately at the corresponding position.

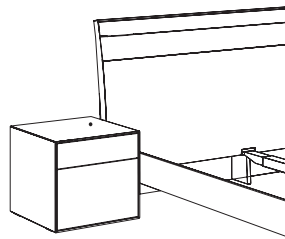

for consoles and chests of the ELUMO II and LUNIS ranges

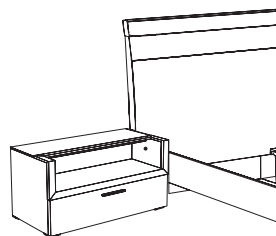

for consoles and chests of the MULTI-VARIS range

### Example 3

Black point = Standard position of Magic-Tronic sensor for hinge- and folding-door wardrobes of the MULTI-FORMA II range

**Notes:**

The black point in the drawings is the area where the Magic-Tronic sensor is invisibly integrated. If the surface is „stroked“ at this position, the lamps are switched on or off.

If you would like to mark the position of the Magic-Tronic sensor on the furniture, you can fit a small metal plate supplied separately at the corresponding position.

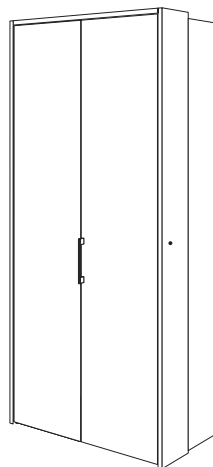

for hinge- and folding-door wardrobes of the MULTI-FORMA II range

## Remote control unit with changing colours

The lamps are normally operated by an external footswitch. The colour temperature of the LED lamps is cold white if a footswitch is used. A 4-channel remote control unit (= transmitter), which is charged extra, is also available as an alternative. Several lamps (up to a total load of a maximum 30 W per transformer and receiver) can be operated with each of the 4 channels. All 4 channels can be dimmed separately at the push of a button. The colour temperature of all 4 channels can be set from cold white (= the basic setting of the LED lamps) to warm white. If warm white is required, a radio remote control unit must be ordered. It is also possible to switch all channels on and off simultaneously with the "all on" or "all off" buttons. Up to 4 transmitters can operate as many receivers as required. Transmitters and receivers must be ordered separately. The footswitch is omitted when the remote control unit is used.

**The following points must be noted with the radio remote control unit:**

- The receiver must be positioned behind a rear wall or under plinth shelves (at least 20 mm space required under plinth shelves).
- The total wattage power of all lamps included per power supply unit/receiver must not exceed 30 W.
- 4 channels = 4 light groups
- 1 light group = x lights
- All lamps within a light group can be dimmed to the same brightness.
- The same light colour can be set for all lamps in all the light groups. This light colour is then valid for all the lamps.
- The remote control unit is not suitable for equipment operating on 110 V!

**Important notes:**

The information on basic settings for the LED lamps as well as setting the colour temperature do not apply to the MEGA-DESIGN and MULTI-VARIS ranges!  
Please be sure to note the operating and programming instructions!

4-channel remote control unit with changing colours

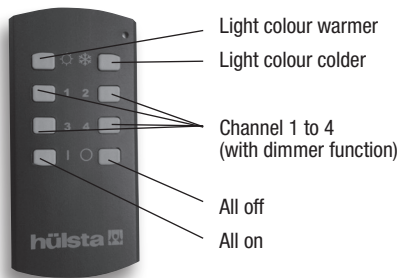

4-channel remote control unit with changing colours

Price per transmitter	type	2016
Price per receiver	type	2017

# Switch options for lamps: Remote control unit with changing colours

## Examples of use (schematic diagrams)

### Example 1

#### Lights inside a unit

Channel 1 operates (and dims) all the lights in light group 1, i.e. the spotlamp in the left cabinet

Channel 2 operates (and dims) all the lights in light group 2, i.e. the spotlamps in the unit above the TV bench

Channel 3 operates (and dims) all the lights in light group 3, i.e. the spotlamp in the right cabinet

Required are:

**1 transmitter** 1x type **2016**  
**1 receiver** 1x type **2017**

Notes:

The total wattage power of all lamps included per power supply unit/receiver must not exceed 30 W. The same light colour can be set for all lamps in all the light groups. This light colour is then valid for all the lamps.

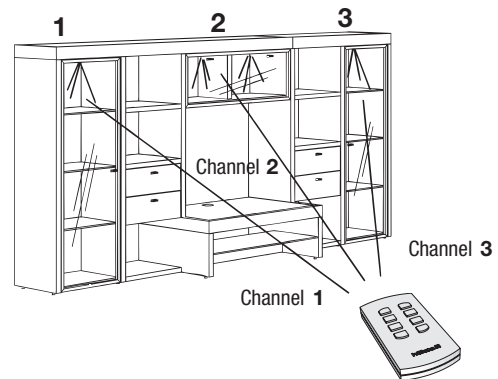

### Example 2

#### Lights in units set apart

Channel 1 operates (and dims) all the lights in light group 1, i.e. the spotlamp and the light panels in the left cabinet

Channel 2 operates (and dims) all the lights in light group 2, i.e. the light panels and the spotlamps in the centre cabinet

Channel 3 operates (and dims) all the lights in light group 3, i.e. the spotlamp in the right cabinet

Required are:

**1 transmitter** 1x type **2016**  
**3 receivers** 3x type **2017**

Notes:

The total wattage power of all lamps included per power supply unit/receiver must not exceed 30 W. The same light colour can be set for all lamps in all the light groups. This light colour is then valid for all the lamps.

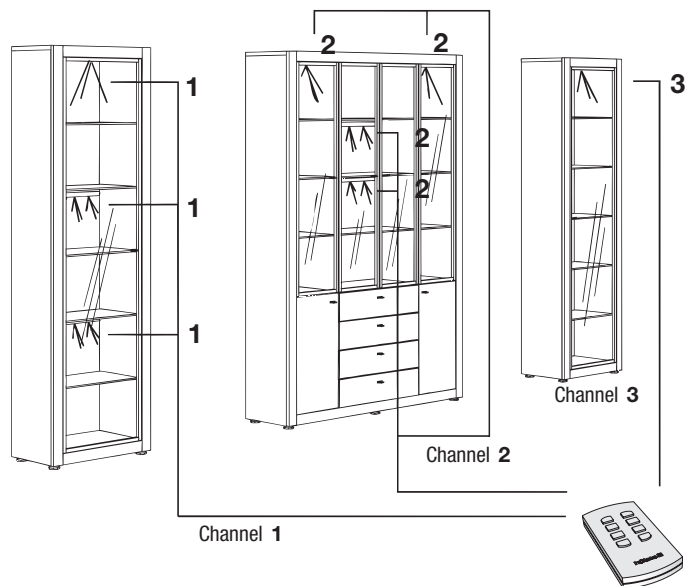

### Example 3

#### Lights in units set apart

Channel 1 operates (and dims) all the lights in light group 1, i.e. the spotlamps in the left, centre and right cabinet

Channel 2 operates (and dims) all the lights in light group 2, i.e. the top light panels in the left, centre and right cabinet

Channel 3 operates (and dims) all the lights in light group 3, i.e. the bottom light panels in the left, centre and right cabinet

Required are:

**1 transmitter** 1x type **2016**  
**3 receivers** 3x type **2017**

Notes:

The total wattage power of all lamps included per power supply unit/receiver must not exceed 30 W. The same light colour can be set for all lamps in all the light groups. This light colour is then valid for all the lamps.

