

TECHNICAL DATA

ROLF BENZ TIRA



**ROLF
BENZ**

- Metal and wooden inner frame with integrated adjustment function
- Seat and backrest in polyurethane foam, built up in coordinated layers varying in height and firmness, coated with a non-woven polyester cover
- Downy-soft cushions with a filling of foam rods and polyester fibres
- Seat height optionally 40 cm or 43 cm
- Base frame in metal, with a choice of finish:
 - painted textured silver
 - painted black RAL 9017
 - painted umbra grey RAL 7022
 - high-gloss chrome

! Wave formation and depressions in the seat area are unavoidable, due to comfort and design reasons, even in high quality Rolf Benz upholstered furniture. All measurements are approximate.

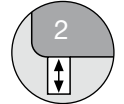
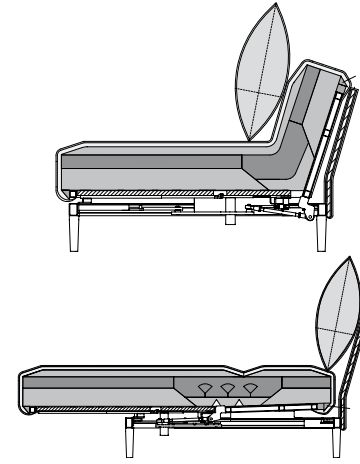

Seat heights available

Sofa with reclining function*

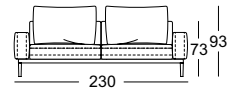
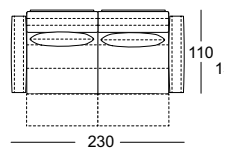

Sectional sofa with reclining function*

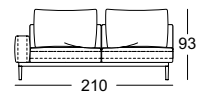
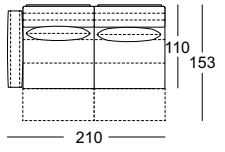

Sectional bench with reclining function

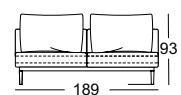
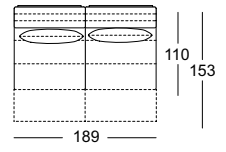

Closing chair with fixed footstool and reclining function*

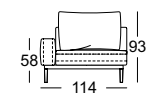
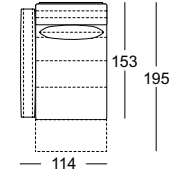

Adjustable back cushion mat

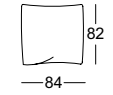
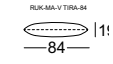

Back cushion

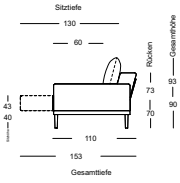
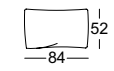
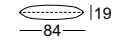

**ROLF
BENZ**

Combination examples

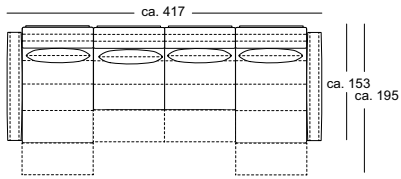

K-L-ASS-PSZ TIRA 114 le.
K-L-ARB TIRA 189
K-L-ASS-PSZ TIRA 114 ri.
4x RUK TIRA 84

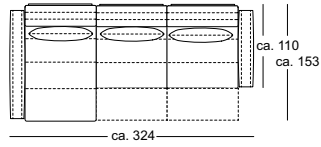

K-ASS-PSZ TIRA 114 le.
K-L-ASO TIRA 210 ri.
3x RUK TIRA 84

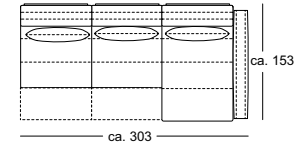

K-L-ARB TIRA 189
K-ASS-PSZ TIRA 114 ri.
3x RUK TIRA 84

*These elements are only shown in the left version. They are also available in the right version.

**ROLF
BENZ**