

now! vision YOU CAN DO IT ALL, BUT YOU DON'T HAVE TO.

What is playful, versatile and yet still clearly arranged? Exactly, now! vision. It betrays a clear line yet is still extremely flexible: the surfaces vary from classical lacquer and high-gloss lacquer fronts to accent versions in stylish petrol, teal blue and old rose as well as high-quality veneers in core walnut and natural oak. Push-to-open technology allows you to open closed units without the need for handles – resulting in a very pure visual effect. And you cannot only play around with the colours, the large selection of available units means that you can plan stacked or wall units variably within the limits of the bookshelf frame system. Suitable designs for the living room, dining room and study make now! vision a futuristic all-rounder.

Planning notes

Lists of versions

Carcase, substructure, metal module versions, bookshelf frame system, desk

Price group I
White lacquer
Grey lacquer
Silk grey lacquer

NEW

Front versions

Price group I
White lacquer
Grey lacquer
Silk grey lacquer

NEW

Price group II
High-gloss white lacquer
High-gloss grey lacquer
High-gloss silk grey lacquer
Natural oak
Core walnut

NEW

Interior fitting, secretaire unit, bar compartment, box drawers versions

Natural oak
Core walnut

NEW

Magnetic box versions

Snow white
Saffron
Moss green
Terra red
Petrol blue
Velvet grey

Accent versions

Price group II
Teal blue lacquer
Petrol lacquer
Old rose lacquer



NEW

Fabric panels
of black or silver fabric,
65% polyamide (glossy),
35% polyester

Usable inside dimensions

Usable inside dimensions of open compartments of lowboards:

Height: 14.4 cm
Width: 49.6 / 67.2 / 102.4 cm
Depth: 43.4 cm

Example:

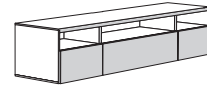

Lowboards, sideboards, assembly units

Carcase in carcase versions

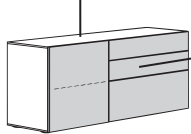

Front in front versions

Open units

Carcase in carcase versions

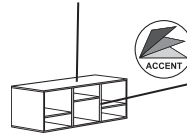

Partitions, fitted shelves and rear wall in carcase versions, in accent versions in natural oak or core walnut

Rear wall with partition

Rear wall with partition in carcase versions, in accent versions, in natural oak or core walnut

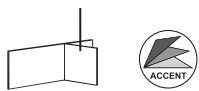

Angled shelves

Wall panel of angled shelves in carcase versions, in accent versions, in natural oak or core walnut; shelf in carcase versions

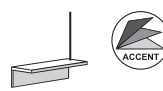

Changing versions:

In now! vision colour combinations within individual units are possible. In this case please state the versions clearly and separately in the order! If versions from different price groups are exchanged, the higher price group is always charged. **Please state all the versions clearly in the order!**

Example:

Carcase in grey lacquer

Door, top drawer and bottom flap in white lacquer

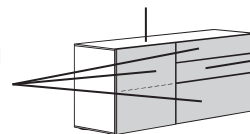

Middle drawer in core walnut

- **hülsta-Push-to-open:** All drawers, hinge-doors and flaps with hülsta-Push-to-open

- Since 1996, we are entitled to label all of our modular furniture and base frames with the strictly regulated "Blue Angel", which awards products that are low in emissions and especially environmentally friendly.





Please be sure to see the „now! general“ chapter on the following subjects:

- Important notes on including lighting
- Remote control set for LED lamps
- IR repeater set for lowboards
- Flatscreen TV sizes overview
- Flap hinge
- Wall units
- Maximum loads
- Quality of walls / assembly instructions

Planning lowboards / side-

Planning step 1

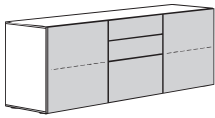

Choice of type

Please note:
Please state all the versions clearly in the order (see here the information on the previous page).

Planning step 2

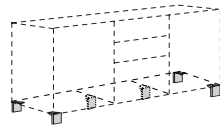

Choice of optional legs/optional substructure

Please note:
Cannot be fitted with sideboards with flush-front sliding-doors

Planning step 3

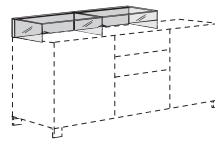

Choice of optional accessories such as:

- Fitted shelf for sideboard
- LED-light strip for sideboard with flush-front sliding-doors
- Glass bonnet for lowboards

Planning step 4

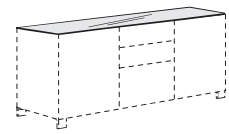

Choice of optional glass cover shelf in the required version

Planning assembly units

Planning step 1

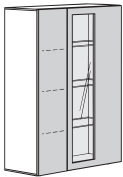

Choice of unit

Please note:
Please state all the versions clearly in the order (see here the information on the previous page). A wall bracket is necessary for fitting as a wall unit (possible up to max. 8R height).

Planning step 2

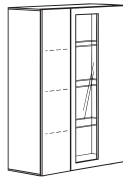

Choice of optional accessories such as:

- Fitted shelf
- Fitted glass shelf
- LED light strip
- LED glass rim lamp
- Glass cover shelf

Stacking assembly units (possible up to 12R total height)



With now! vision it is possible to stack assembly units up to a maximum height of 12R. In this case a wall bracket must be ordered for each stacked unit.

Planning the bookshelf frame system

Planning step 1

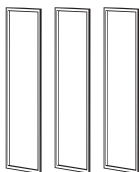

Choice of bookshelf frames in the required number and version

Please note: 2 outer bookshelf frames must be included in every bookshelf frame combination. As many centre bookshelf frames can be included as required.

Planning step 2



Choice of fitted shelves, rear walls with partition and assembly units in the required number and version

Please note: A rear wall with partition can only be fitted in combination with assembly units and/or fitted shelves. If assembly units are fitted between bookshelf frames, a fitted shelf is essential at the bottom of the lowest assembly unit. If assembly units up to 4 Raster height are fitted, a wall bracket must be ordered. The same applies to every other fitted assembly unit. For constructional reasons at least 2 fitted shelves must be included, for 12 Raster bookshelf frames a third shelf must be included. 6 Raster bookshelf frames may only be stacked to a maximum 4 Raster height, 8 Raster bookshelf frames may only be stacked to a maximum 6 Raster height and 12 Raster bookshelf frames may only be stacked to a maximum 8 Raster height.

Planning step 3



Choice of optional spacer bars in the required number and version

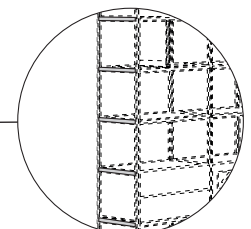

Carcase, substructure, metal module versions, bookshelf frame system, desk

Accent versions

Price group I
White lacquer
Grey lacquer
Silk grey lacquer

Price group II
Teal blue lacquer
Petrol lacquer
Old rose lacquer



Special combinations

Special combinations are arrangements that are reduced in price. This price advantage is only available when the arrangement is ordered exactly as described. The special combinations can be enhanced by including accessories. These are charged extra.

ADVANTAGE!

NEW

Special combination

Recommended accessories

Article	Order no.	RRP *
1x Glass cover shelf	19521	
1x Metal substructure	1411	
or 1x legs (set of 6)	1402	

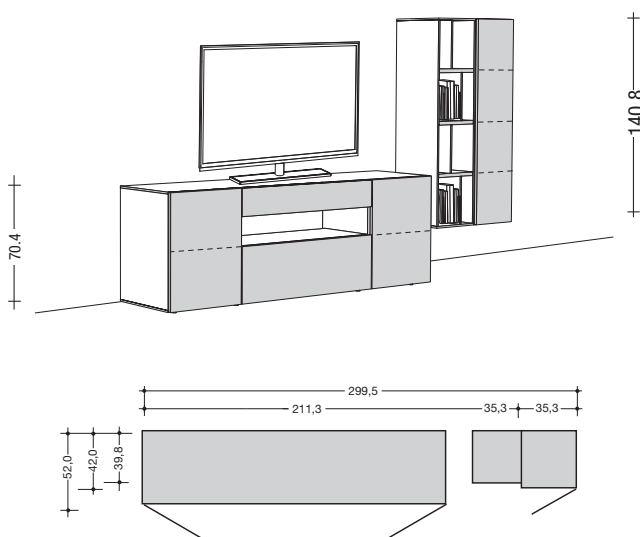

Article	Special combination
Order no.	990010 (as illustrated) / 991010 (vice versa)
Price group I *	
Price group II *	

Special combination

Recommended accessories

Article	Order no.	RRP *
1x Glass cover shelf	19521	
1x Metal substructure	1411	
or 1x legs (set of 6)	1402	
1x Support for soundbar	1011	
1x LED glass rim lamp	1671	

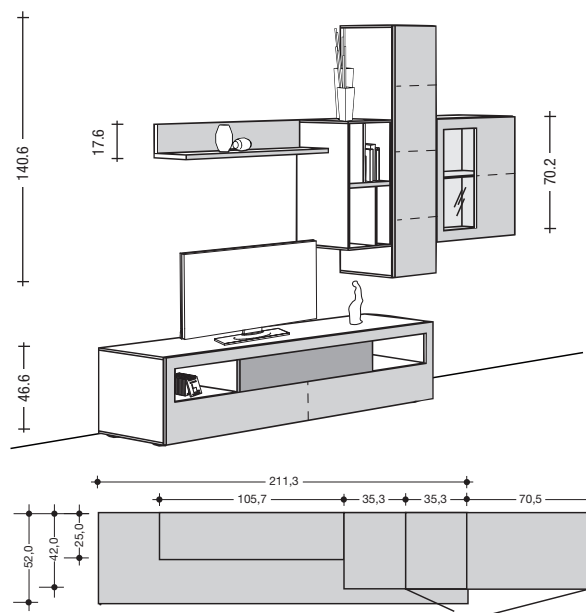

Information on the energy class: see the description of the individual units!

Article	Special combination
Order no.	990001 (as illustrated) / 991001 (vice versa)
Price group I *	
Price group II *	

Front versions

Type list

now! vision
by hülsta

● ● ● made in germany

Price group I	Price group II
White lacquer	High-gloss white lacquer
Grey lacquer	High-gloss grey lacquer
Silk grey lacquer	High-gloss silk grey lacquer
	Natural oak
	Core walnut

Special combinations are arrangements that are reduced in price. This price advantage is only available when the arrangement is ordered exactly as described. The special combinations can be enhanced by including accessories. These are charged extra.

ADVANTAGE!

NEW

Special combination

Recommended accessories

Article	Order no.	RRP *
1x Interior fitting	144	
1x box drawers for interior fitting	14	
1x Glass cover shelf	19521	
1x Metal substructure or 1x legs (set of 6)	1411	
1x LED glass rim lamp	1402	
1x LED light strip	1671	
	1621	

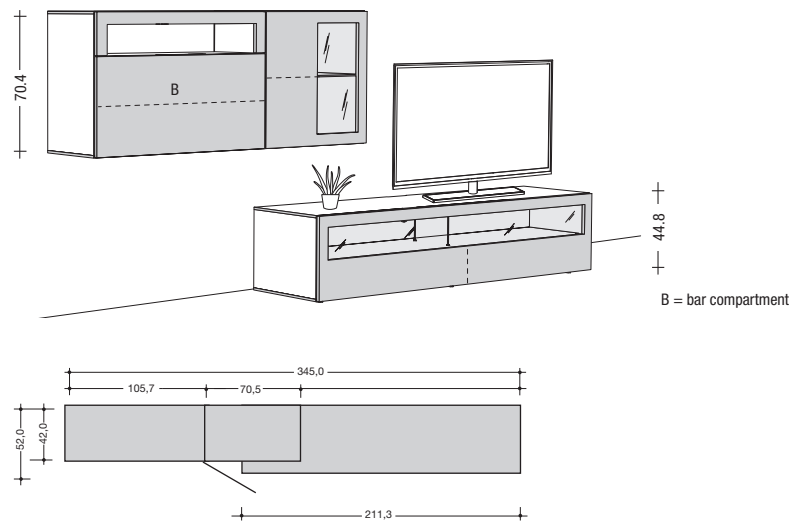

Information on the energy class:
see the description of the individual units!

Article	Special combination
Order no.	990009 (as illustrated) / 991009 (vice versa)
Price group I *	
Price group II *	

NEW

Special combinations

Recommended accessories for 990007/991007

Article	Order no.	RRP *
1x Glass cover shelf	19521	
1x Metal substructure or 1x legs (set of 6)	1411	
1x Support for soundbar	1402	
1x Support for soundbar	1011	
4x LED glass rim lamp	4x 1671	4x

Recommended accessories for 990006/991006

Article	Order no.	RRP *
1x LED light strip	1621	

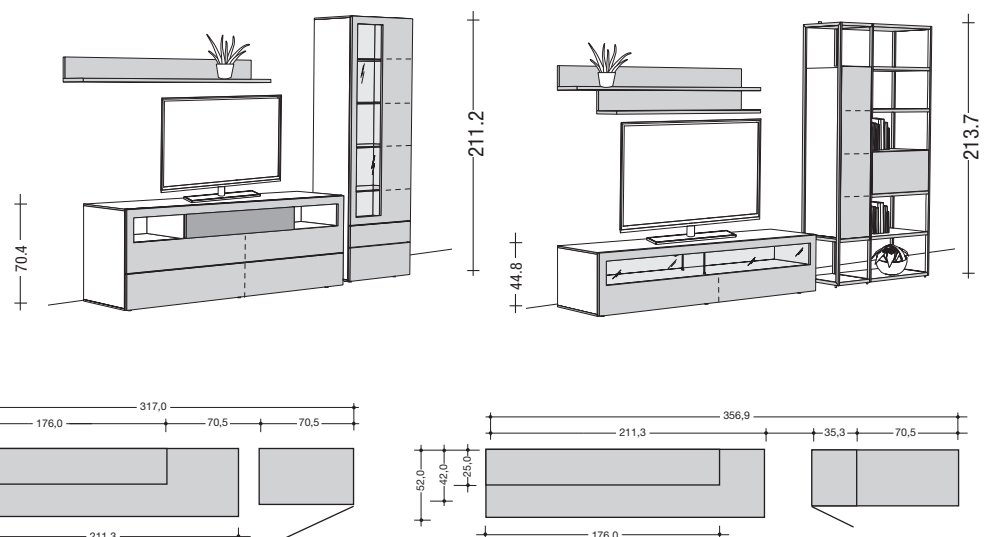

Information on the energy class:
see the description of the individual units!

Article	Special combination
Order no.	990007 (as illustrated) / 991007 (vice versa)
Price group I *	
Price group II *	

E

Carcase, substructure, metal module versions, bookshelf frame system, desk

Accent versions

Price group I
White lacquer
Grey lacquer
Silk grey lacquer

Price group II
Teal blue lacquer
Petrol lacquer
Old rose lacquer



Suggested combinations

As an alternative to planning an individual unit from the complete range there is the possibility of choosing from specially suggested combinations. This eases planning. Incorporating accessories can enhance the suggested combinations. These are charged extra.

NEW

Suggested combinations

Recommended accessories for 980005

Article	Order no.	RRP *
1x Glass cover shelf	19521	

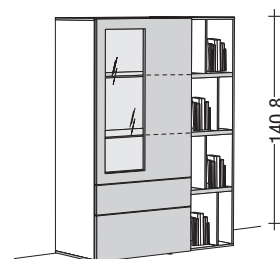
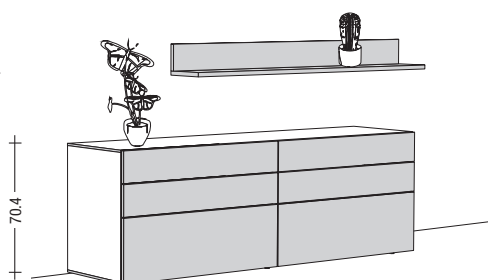

Recommended accessories for 980006/981006

Article	Order no.	RRP *
2x LED glass rim lamp	2x 1671	2x

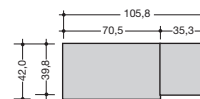
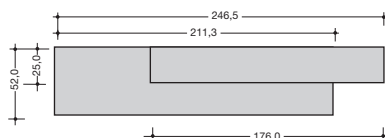

Article	Suggested combination	
Order no.	980005	980006 (as illustrated) / 981006 (vice versa)
Price group I *		
Price group II *		

NEW

Suggested combinations

Recommended accessories

Article	Order no.	RRP *
1x Interior fitting	144	
1x box drawers for interior fitting	14	

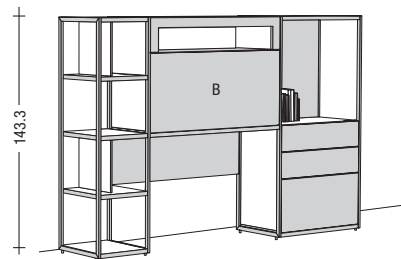
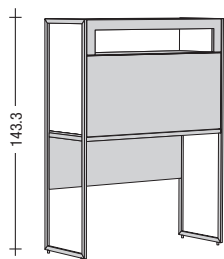

B = bar compartment

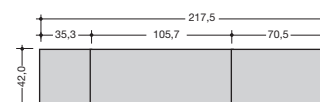
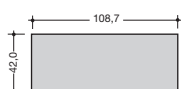

Article	Suggested combination		
Order no.	Secretaire unit 8141	Bar compartment 8142	980008 (as illustrated) / 981008 (vice versa)
Price group I *			
Price group II *			

Front versions

Type list

now! vision
by hülsta

● ● ● made in germany

Price group I
White lacquer
Grey lacquer
Silk grey lacquer

Price group II
High-gloss white lacquer
High-gloss grey lacquer
High-gloss silk grey lacquer
Natural oak
Core walnut

As an alternative to planning an individual unit from the complete range there is the possibility of choosing from specially suggested combinations. This eases planning. Incorporating accessories can enhance the suggested combinations. These are charged extra.

NEW

Suggested combinations

Recommended accessories

Article	Order no.	RRP *
1x rear wall with partition 35,3 cm wide	17381	
1x rear wall with partition 105,7 cm wide	17161	

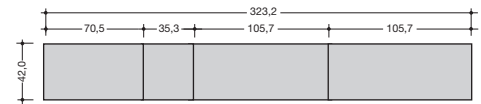
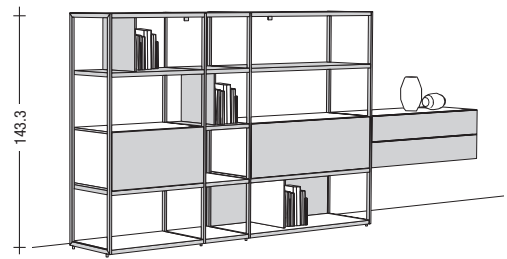
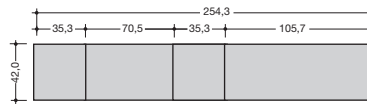
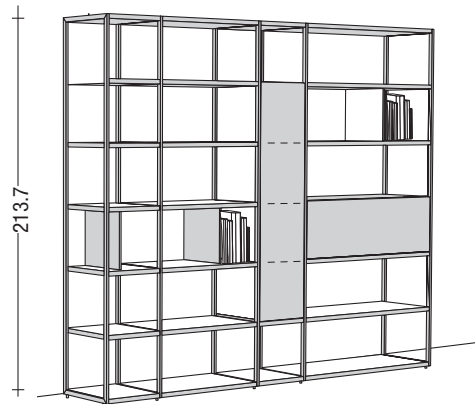

Article	Suggested combination	
Order no.	980009 (as illustrated) / 981009 (vice versa)	980010 (as illustrated) / 981010 (vice versa)
Price group I *		
Price group II *		

NEW

Suggested combinations

Recommended accessories

Article	Order no.	RRP *
3x LED glass rim lamp	3x 1636	
1x LED light strip	1635	

Information on the energy class:
see the description of the individual units!

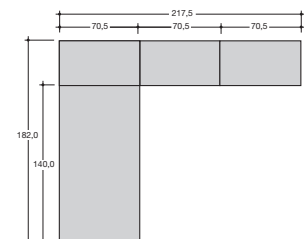
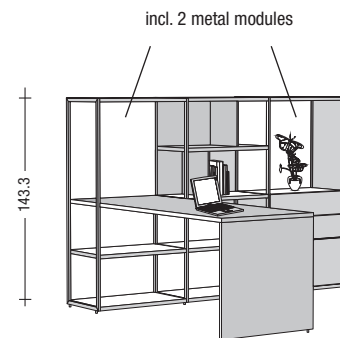
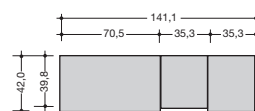
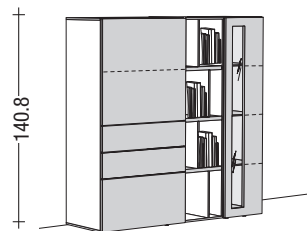

Article	Suggested combination	
Order no.	980011 (as illustrated) / 981011 (vice versa)	980012 (as illustrated) / 981012 (vice versa)
Price group I *		
Price group II *		

Price group I
White lacquer
Grey lacquer
Silk grey lacquer

Lowboards

Please note: Cover shelf of lowboards always with cable groove at rear rim. Accessories for lowboards: see next double page!

IR repeater set for lowboards:

Type **7777**

Lowboards 2.5R

44.8 cm high
(46.6 cm high
incl. 1.8 cm
high legs)

1 open compartment;
1 flap

1 open compartment;
1 drawer

2 open compartments;
1 flap

2 open compartments;
1 flap; 1 drawer

3 open compartments;
1 drawer left and right;
1 flap

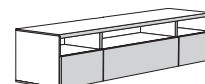
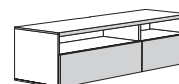
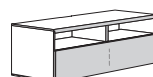
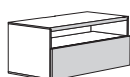
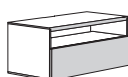

Article	Lowboards 2.5R				
H x W x D in cm	44.8 x 105.7 x 52	44.8 x 105.7 x 52	44.8 x 140.9 x 52	44.8 x 176.1 x 52	44.8 x 211.3 x 52
Order no.	1551	1552	1553	15591 (as ill.) / 15592 (v.v.)	1560
Price group I *					
Price group II *					

Lowboards 2.5R

44.8 cm high
(46.6 cm high
incl. 1.8 cm
high legs)

1 flap

2 drawers

1 flap

1 flap; 2 drawers

2 drawers; 1 flap

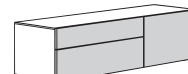
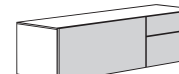
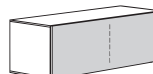
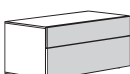
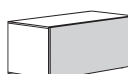

Article	Lowboards 2.5R				
H x W x D in cm	44.8 x 105.7 x 52	44.8 x 105.7 x 52	44.8 x 140.9 x 52	44.8 x 176.1 x 52	44.8 x 176.1 x 52
Order no.	1251	1252	1253	12541 (as ill.) / 12542 (v.v.)	12551 (as ill.) / 12552 (v.v.)
Price group I *					
Price group II *					

Lowboards 2.5R

44.8 cm high
(46.6 cm high
incl. 1.8 cm
high legs)

2 flaps; 2 drawers

2 drawers; 1 flap

1 flap with clear glass panel;
incl. 1 fitted shelf and metal
supports

1 flap with clear glass panel;
incl. 1 fitted shelf and metal
supports

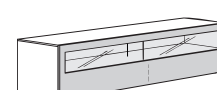
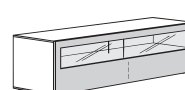
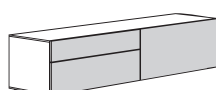
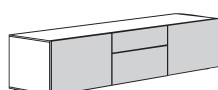

Article	Lowboards 2.5R			
H x W x D in cm	44.8 x 211.3 x 52	44.8 x 211.3 x 52	44.8 x 176.1 x 52	44.8 x 211.3 x 52
Order no.	1256	12571 (as ill.) / 12572 (v.v.)	1358	1359
Price group I *				
Price group II *				

Front versions

Price group I
White lacquer
Grey lacquer
Silk grey lacquer

Price group II
High-gloss white lacquer
High-gloss grey lacquer
High-gloss silk grey lacquer
Natural oak
Core walnut

Type list



● ● ● made in germany

Lowboards for sound systems

Please note: Cover shelf of lowboards always with cable groove at rear rim. The panel of the lowboards lined with fabric is especially suitable for accommodating hidden audio units! Accessories for lowboards: see next double page!



IR repeater set for lowboards:
Type 7777

Lowboards 2.5R

44.8 cm high
(46.6 cm high
incl. 1.8 cm
high legs)

1 panel lined with fabric; 1 drawer

1 panel lined with fabric; 1 flap

1 panel lined with fabric; 2 drawers

1 panel lined with fabric; 1 drawer; 1 flap

1 panel lined with fabric; 1 drawer; 1 flap

Fabric panels optionally black or silver
Usable inside dimensions behind panel: 14.4 x 100.4 x 43.3 cm (H x W x D)

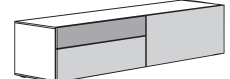
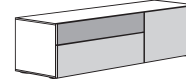
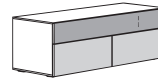
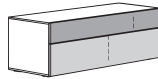
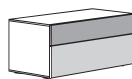

Article	Lowboards 2.5R				
H x W x D in cm	44.8 x 105.7 x 52	44.8 x 140.9 x 52	44.8 x 140.9 x 52	44.8 x 176.1 x 52	44.8 x 211.3 x 52
Order no.	1361	1362	1363	13641 (as ill.) / 13642 (v.v.)	13651 (as ill.) / 13652 (v.v.)
Price group I *					
Price group II *					

Lowboards 2.5R

44.8 cm high
(46.6 cm high
incl. 1.8 cm
high legs)

1 flap with integrated, fabric lined panel and open compartment; incl. 1 fitted shelf

1 flap with integrated, fabric lined panel and open compartment; incl. 1 fitted shelf

Usable inside width behind panel: 99.4 cm

Usable inside dimensions of lowboards behind panel: height 20.8 cm; depth 43.3 cm

Usable inside width behind panel: 102.4 cm

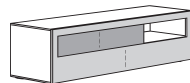

Fabric panels optionally black or silver

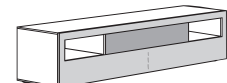

Article	Lowboards 2.5R	
H x W x D in cm	44.8 x 176.1 x 52	44.8 x 211.3 x 52
Order no.	13661 (as ill.) / 13662 (v.v.)	1367
Price group I *		
Price group II *		

NEW

Lowboards 4R

70.4 cm high
(72.2 cm high
incl. 1.8 cm
high legs)

2 doors, 1 drawer, 1 open compartment, 1 flap

1 flap with integrated, fabric lined panel, 1 flap

Fabric panels optionally black or silver

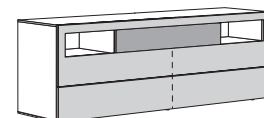
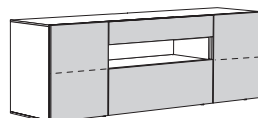

Article	Lowboards 4R	
H x W x D in cm	70.4 x 211.3 x 52	70.4 x 211.3 x 52
Order no.	1466	1467
Price group I *		
Price group II *		

Price group I
White lacquer
Grey lacquer
Silk grey lacquer

Accessories for lowboards

Metal substructures

Optional substructure for lowboards, 12.0 cm high, 48.0 cm deep.
Substructure of metal, powder-coated white, grey or silk grey (price group I) or of stainless steel (price group II).

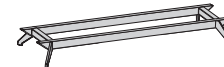
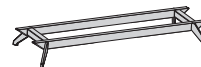
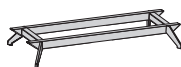
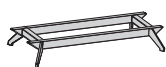

Article	Metal substructures for lowboards			
	for 105.7 cm width	for 140.9 cm width	for 176.1 cm width	for 211.3 cm width
Order no.	1405	1404	1407	1411
Price group I *				
Price group II *				

Glass bonnet, legs

Glass bonnet of stained glass. Rear wall of glass bonnet in carcass version

Optional legs for lowboards, silver coloured

Usable inside dims. per compartment:
Height: 15.2 cm
Width: 68.7 cm
Depth: 37.2 cm

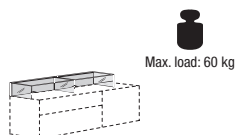

Set of 5 (for 105.7 and 140.9 cm width)

Set of 6 (for 176.1 and 211.3 cm width)

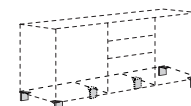
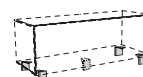

Article	Glass bonnet	Article	Legs for lowboards	
	H x W x D in cm		8.6 x 9.2 x 2	
Order no.	1140	Order no.	1401	1402
RRP *		RRP *		

Fitted shelves

fitted behind flaps and doors of the lowboards

behind 70.5 cm wide flap behind 105.7 cm wide flap behind 52.3 cm wide door behind 69.9 cm wide door behind 105.1 cm wide doors



Article	Fitted shelves for lowboards				
	3.2 x 67.2 x 43.4	3.2 x 102.4 x 43.4	3.2 x 49.6 x 40.9	3.2 x 67.2 x 40.9	3.2 x 102.4 x 40.9
Order no.	1270	1215	1052	1072	1100
Price group I *					
Price group II *	-	-	-	-	-

Glass cover shelves

Optional glass cover shelf for lowboards of rear-lacquered glass, white, grey or silk grey.
Please state the required version clearly in the order!



Article	Glass cover shelves			
	0.8 x 105.7 x 52	0.8 x 140.9 x 52	0.8 x 176.1 x 52	0.8 x 211.3 x 52
Order no.	19510	19514	19517	19521
RRP *				

Front versions

Type list

now! vision
by hülsta

● ● ● made in germany

Price group I	Price group II
White lacquer	High-gloss white lacquer
Grey lacquer	High-gloss grey lacquer
Silk grey lacquer	High-gloss silk grey lacquer
	Natural oak
	Core walnut

Accessories for lowboards

Lamps

LED light strip; fitted behind flaps or in open compartments;
incl. footswitch and preliminary transformer. Later fitting is not possible.

This luminaire contains built-in LED lamps of the energy classes A++ to A.
The lamps cannot be changed in the luminaire. 12 V

Remote control
for LED lamps:
Type 3333



Article	LED light strips for lowboards with partitions / open compartments				LED light strips for lowboards behind clear glass panel	
	for 105.7 cm width; 3.7 W	for 140.9 cm width; 4.6 W	for 176.1 cm width; 6.0 W	for 211.3 cm width; 7.3 W	for 176.1 cm width; 6.7 W	for 211.3 cm width; 8.2 W
Order no.	1615	1640	1672	1611	1676	1621
RRP *						

Support for sound bar

Support for sound bar for fitting behind fabric lined panel of lowboards

for lowboards with fabric lined panel with an inside
compartment height of **14.4 cm**; max. usable inside
compartment dimensions for sound bar:
12.3 x 102.4 x 24.5 cm (H x W x D)

for lowboards with fabric lined panel with an inside
compartment height of **20.8 cm**; max. usable inside
compartment dimensions for sound bar:
18.7 x 102.4 x 24.5 cm (H x W x D)

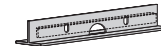
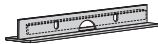

Article	Support for sound bar	
H x W x D in cm	14.4 x 102.4 x 21.4	20.8 x 102.4 x 21.4
Order no.	1010	1011
RRP *		

Cable aperture

silver-coloured

It is possible to fit a cable aperture in the cover shelf of the lowboard. The cable aperture can be made at the rear of the cover shelf (not possible above partitions). Please state the required position of the cable aperture clearly in the order!

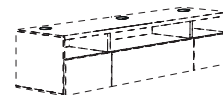
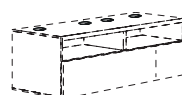

Article	Cable aperture
Order no.	Ø 8.0 cm
RRP *	N1

E

Carcase, substructure, metal module versions, bookshelf frame system, desk

Price group I
White lacquer
Grey lacquer
Silk grey lacquer

Front versions

Price group I
White lacquer
Grey lacquer
Silk grey lacquer

Price group II
High-gloss white lacquer
High-gloss grey lacquer
High-gloss silk grey lacquer
Natural oak
Core walnut

Sideboards, accessories for sideboards

Sideboards 4R

1 door; 2 drawers; 1 flap

1 door; 3 drawers

6 drawers

2 flush-front sliding-doors with clear glass panel; on arched supports (metal substructure not possible)

70.4 cm high
(72.2 cm high
incl. 1.8 cm high legs)

70.4 cm high
(79.0 cm high on 8.6 cm
high arched supports)

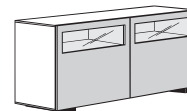
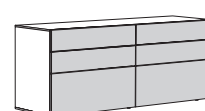
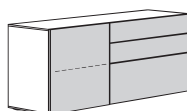
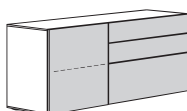

NEW

Article	Sideboards 4R			
H x W x D in cm	70.4 x 176.1 x 52	70.4 x 176.1 x 52	70.4 x 176.1 x 52	70.4 x 176.1 x 52
Order no.	14171 (as ill.) / 14172 (v.v.)	14271 (as ill.) / 14272 (v.v.)	1419	1418
Price group I *				
Price group II *				

Sideboards 4R

2 doors; 2 drawers; 1 flap

2 doors; 3 drawers

6 drawers

2 flush-front sliding-doors with clear glass panel; on arched supports (metal substructure not possible)

70.4 cm high
(72.2 cm high
incl. 1.8 cm high legs)

70.4 cm high
(79.0 cm high on 8.6 cm
high arched supports)

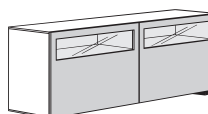
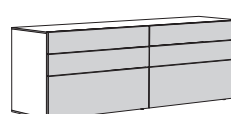
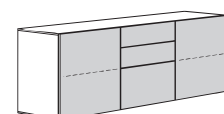
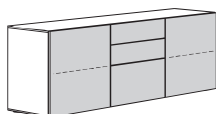

NEW

Article	Sideboards 4R			
H x W x D in cm	70.4 x 211.3 x 52	70.4 x 211.3 x 52	70.4 x 211.3 x 52	70.4 x 211.3 x 52
Order no.	1421	1431	1423	1422
Price group I *				
Price group II *				

Metal substructures, legs

Optional substructure and legs for sideboards. Substructure 12.0 cm high, 48.0 cm deep, of metal, powder-coated white, grey or silk grey (price group I) or of stainless steel (price group !!). Legs silver coloured (substructure and legs can not be fitted on 4R sideboards with flush-front sliding doors)

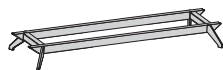
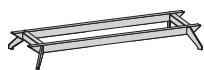

Set of 6 (for 176.1 and 211.3 cm width)

Article	Metal substructures for sideboards		Legs for sideboards
	for 176.1 cm width	for 211.3 cm width	8.6 x 9.2 x 2
Order no.	1407	1411	1402
Price group I *			
Price group II *			

Glass cover shelves

Optional glass cover shelf for sideboards of rear-lacquered glass, white, grey or silk grey. Please state the required version clearly in the order!

Fitted shelf

behind 70.5 cm wide door



Article	Glass cover shelves	
H x W x D in cm	0.8 x 176.1 x 52	0.8 x 211.3 x 52
Order no.	19517	19521
RRP *		

Article	Fitted shelf for sideboards
H x W x D in cm	3.2 x 67.2 x 47.6
Order no.	1271
Price group I *	
Price group II *	

Lamps

LED light strip; fitted behind flush-front sliding-doors with clear glass panel; incl. footswitch and preliminary transformer. Later fitting is not possible.

This luminaire contains built-in LED lamps of the energy classes A++ to A.
The lamps cannot be changed in the luminaire. 12 V

Remote control
for LED lamps:
Type 3333



Article	LED light strip for sideboards (set of 2)	
H x W x D in cm	for 176.1 cm width; 3.0 W	for 211.3 cm width; 3.7 W
Order no.	1677	1622
RRP *		

Interior fitting, secretaire unit, bar compartment, box drawers versions

Natural oak
Core walnut

Type list

now! vision
by hülsta

● ● ● made in germany

Single units, secretaire unit and bar compartment

NEW

Single units with secretaire unit and bar compartment

Single unit with 1 flap and open compartment

incl. USB/socket set

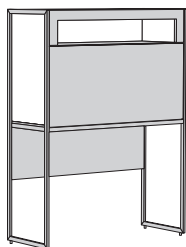

inkl. mirror and glass shelf

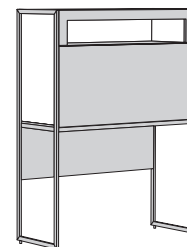

Article	Secrétaire unit	Bar compartment
H x W x D in cm	143.3 x 108.7 x 42.1	143.3 x 108.7 x 42.1
Order no.	8141	8142
Price group I *		
Price group II *		

NEW

Secrétaire unit and bar compartment

Writing and bar compartments can be fitted between carcasses and shelf frames as well as being used as wall units

Writing and bar compartment with 1 flap and 1 open compartment

Secrétaire unit and bar compartment
always incl. wall bracket

incl. USB/socket set

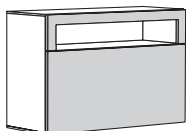

inkl. mirror and glass shelf

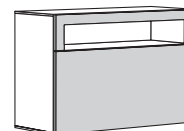

Article	Secrétaire unit	Bar compartment
H x W x D in cm	70.4 x 105.7 x 42.0	70.4 x 105.7 x 42.0
Order no.	141	142
Price group I *		
Price group II *		

NEW

Interior fitting, box drawers, LED light strip

Interior fitting and box drawer in natural oak and core walnut

Interior fitting consisting of:
1 niche rear wall
2 partitions, 1 shelf

LED lamp, with automatic switch and motion detector, incl. preliminary transformer.

This luminaire contains built-in LED lamps of the energy classes A++ to A. The lamps cannot be changed in the luminaire. 12 V

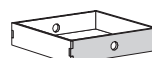

Article	Interior fitting	Box drawer for inside compartment	LED light strip
H x W x D in cm	18.2 x 102.4 x 37.7	6.7 x 30.9 x 30.1	2.75 W
Order no.	144	14	15
RRP *			

E

Carcase, substructure, metal module versions, bookshelf frame system, desk

Accent versions

Price group I
White lacquer
Grey lacquer
Silk grey lacquer

Price group II
Teal blue lacquer
Petrol lacquer
Old rose lacquer



Open units

35.2/70.4/140.8 cm high
(37.0/72.2/142.6 cm high
incl. 1.8 cm high legs)

Carcase of the open units in carcass versions; partitions, fitted shelves and rear wall in all carcass and accent versions as well as in natural oak and core walnut. Please state the required version clearly in the order!
Open units always incl. wall bracket.



Article	Open units 2R	
H x W x D in cm	35.2 x 35.3 x 39.8	35.2 x 70.5 x 39.8
Order no.	17351 (as illustrated) / 17352 (vice versa)	17701 (as illustrated) / 17702 (vice versa)
Price group I *		
Price group II *		

Assembly units 2R

35.2 cm high
(37.0 cm high
incl. 1.8 cm
high legs)

1 flap

1 drawer

2 drawers

1 flap with clear glass panel



Article	Assembly units 2R			
H x W x D in cm	35.2 x 70.5 x 42	35.2 x 70.5 x 42	35.2 x 70.5 x 42	35.2 x 70.5 x 42
Order no.	1201	1208	1202	1203
Price group I *				
Price group II *				

Assembly units 4R

70.4 cm high
(72.2 cm high
incl. 1.8 cm
high legs)

1 door

1 door

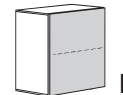

Article	Assembly units 4R	
H x W x D in cm	70.4 x 35.3 x 42	70.4 x 70.5 x 42
Order no.	14351 L / 14352 R	14701 L / 14702 R
Price group I *		
Price group II *		

Assembly units 4R

70.4 cm high
(72.2 cm high
incl. 1.8 cm
high legs)

1 door; 3 drawers

1 door; 1 door with clear glass panel

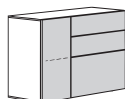

Article	Assembly units 4R	
H x W x D in cm	70.4 x 105.7 x 42	70.4 x 105.7 x 42
Order no.	14181 (as illustrated) / 14182 (vice versa)	14161 (as illustrated) / 14162 (vice versa)
Price group I *		
Price group II *		

Glass cover shelves

Optional glass cover shelf for open units and assembly units of rear-lacquered glass, white, grey or silk grey. Please state the required version clearly in the order!



Article	Glass cover shelves					
H x W x D in cm	0.8 x 35.3 x 42	0.8 x 70.5 x 42	0.8 x 105.7 x 42	0.8 x 140.9 x 42	0.8 x 176.1 x 42	0.8 x 211.3 x 42
Order no.	19435	19470	19410	19414	19417	19421
RRP *						

Front versions

Type list

now! vision
by hülsta

● ● ● made in germany

Price group I
White lacquer
Grey lacquer
Silk grey lacquer

Price group II
High-gloss white lacquer
High-gloss grey lacquer
High-gloss silk grey lacquer
Natural oak
Core walnut

Carcase of the open units in carcass versions; partitions, fitted shelves and rear wall in all carcass and accent versions as well as in natural oak and core walnut. Please state the required version clearly in the order!
Open units always incl. wall bracket.

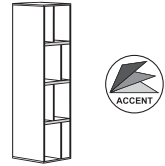
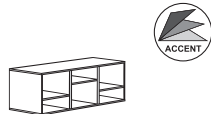

Article	Open unit 2R	Open unit 4R	Open unit 8R
H x W x D in cm	35.2 x 105.7 x 39.8	70.4 x 35.3 x 39.8	140.8 x 35.3 x 39.8
Order no.	1715	17361 (as illustrated) / 17362 (vice versa)	17371 (as illustrated) / 17372 (vice versa)
Price group I *			
Price group II *			

1 flap

2 drawers

1 flap with clear glass panel

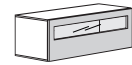
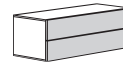
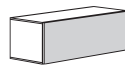

Article	1 flap	2 drawers	1 flap with clear glass panel
H x W x D in cm	35.2 x 105.7 x 42	35.2 x 105.7 x 42	35.2 x 105.7 x 42
Order no.	1205	1206	1207
Price group I *			
Price group II *			

3 drawers

1 door with clear glass panel

2 doors

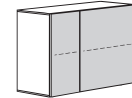
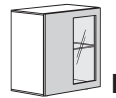

Article	3 drawers	1 door with clear glass panel	2 doors
H x W x D in cm	70.4 x 70.5 x 42	70.4 x 70.5 x 42	70.4 x 105.7 x 42
Order no.	1473	14721 L (as ill.) / 14722 R (v.v.)	14151 (as ill.) / 14152 (v.v.)
Price group I *			
Price group II *			

Wall brackets for 2R and 4R assembly units

Lamps and fitted shelves for 2R and 4R assembly units: see next double page!

Necessary for wall assembly of the 2R and 4R assembly units.

Article	Wall bracket		
	for 35.3 cm wide assembly units	for 70.5 cm wide assembly units	for 105.7 cm wide assembly units
Order no.	1002	1004	1008
RRP *			

Price group I
White lacquer
Grey lacquer
Silk grey lacquer

Assembly units 8R

140.8 cm high
(142.6 cm high incl. 1.8 cm high legs)

1 door

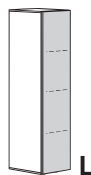

2 doors

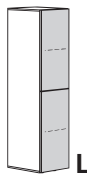

1 door with clear glass panel

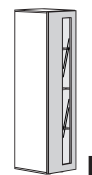

Article	Assembly units 8R		
H x W x D in cm	140.8 x 35.3 x 42	140.8 x 35.3 x 42	140.8 x 35.3 x 42
Order no.	18311 L / 18312 R	18321 L / 18322 R	18331 L (as illustrated) / 18332 R (vice versa)
Price group I *			
Price group II *			

Assembly units 8R

140.8 cm high
(142.6 cm high incl. 1.8 cm high legs)

1 door with clear glass panel

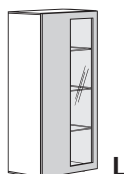

1 door with clear glass panel, 2 drawers

NEW

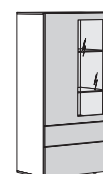

Article	Assembly units 8R	
H x W x D in cm	140.8 x 70.5 x 42	140.8 x 70.5 x 42
Order no.	18741 L (as illustrated) / 18742 R (vice versa)	18551 L (as illustrated) / 18552 R (vice versa)
Price group I *		
Price group II *		

Assembly units 12R

211.2 cm high
(213.0 cm high incl. 1.8 cm high legs)

Cannot be fitted as wall units.

2 doors

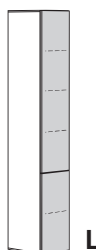

4 doors



1 door with clear glass panel

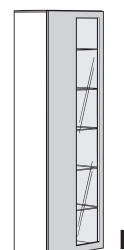

1 door with clear glass panel, 2 drawers

NEW

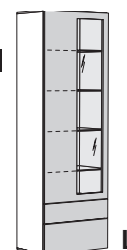

Article	Assembly units 12R			
H x W x D in cm	211.2 x 35.3 x 42	211.2 x 70.5 x 42	211.2 x 70.5 x 42	211.2 x 70.5 x 42
Order no.	11311 L / 11312 R	1171	11731 L (as ill.) / 11732 R (vice versa)	11741 L (as illustrated) / 11742 R (vice versa)
Price group I *				
Price group II *				

Glass cover shelves

Optional glass cover shelf for assembly units of rear-lacquered glass, white, grey or silk grey. Please state the required version clearly in the order!



Article	Glass cover shelves					
H x W x D in cm	0.8 x 35.3 x 42	0.8 x 70.5 x 42	0.8 x 105.7 x 42	0.8 x 140.9 x 42	0.8 x 176.1 x 42	0.8 x 211.3 x 42
Order no.	19435	19470	19410	19414	19417	19421
RRP *						

Lamps for 2R, 4R, 8R and 12R assembly units: LED light strips

LED light strip; fitted in assembly units behind flaps or doors with clear glass panel; incl. footswitch and preliminary transformer. Later fitting is not possible.

This luminaire contains built-in LED lamps of the energy classes A++ to A. The lamps cannot be changed in the luminaire. 12 V

Remote control for LED lamps: Type 3333



Article	LED light strip for assembly units		
Order no.	for 35.3 cm width; 0.8 W	for 70.5 cm width; 2.3 W	for 105.7 cm width; 3.7 W
RRP *	1635	1670	1615

Front versions

Type list

now! vision
by hülsta

● ● ● made in germany

Price group I	Price group II
White lacquer	High-gloss white lacquer
Grey lacquer	High-gloss grey lacquer
Silk grey lacquer	High-gloss silk grey lacquer
	Natural oak
	Core walnut

1 door; 3 drawers

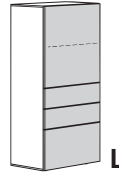

2 doors



Article	Assembly units 8R	
H x W x D in cm	140.8 x 70.5 x 42	140.8 x 70.5 x 42
Order no.	18711 L / 18712 R	1872
Price group I *		
Price group II *		

1 door; 1 door with clear glass panel

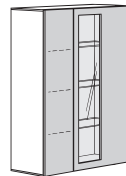

2 doors; 3 drawers



1 door with clear glass panel;
1 door; 3 drawers

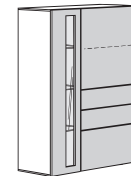

Article	Assembly units 8R		
H x W x D in cm	140.8 x 105.7 x 42	140.8 x 105.7 x 42	140.8 x 105.7 x 42
Order no.	18521 (as illustrated) / 18522 (vice versa)	18531 (as illustrated) / 18532 (vice versa)	18541 (as illustrated) / 18542 (vice versa)
Price group I *			
Price group II *			

High-gloss care set

Polish, polishing sponge and polishing cloth (incl. instructions) for protecting and maintaining the high-gloss surfaces

Article	High-gloss care set
Order no. RRP *	4444

Fitted shelves for 4R, 8R and 12R assembly units

Article	Fitted shelves		Fitted glass shelves	
	3.2 x 32 x 37.7 (for 35.3 cm wide assembly units)	3.2 x 67.2 x 37.7 (for 70.5 cm wide assembly units)	0.8 x 32 x 37.7 (for 35.3 cm wide assembly units)	0.8 x 67.2 x 37.7 (for 70.5 cm wide assembly units)
Order no.	1035	1070	1036	1071
Price group I *				
Price group II *	-	-	-	-

Wall brackets for 8R assembly units

Necessary for wall assembly of the 8R assembly units. 12R assembly units cannot be fitted as wall units!

Article	Wall bracket		
	for 35.3 cm wide assembly units	for 70.5 cm wide assembly units	for 105.7 cm wide assembly units
Order no.	1002	1004	1008
RRP *			

Lamps for 2R, 4R, 8R and 12R assembly units: LED glass rim lamps

LED glass rim lamp; fitted in assembly units behind fitted glass shelves; incl. footswitch and preliminary transformer. Later fitting is not possible.

This luminaire contains built-in LED lamps of the energy classes A+++ to A. The lamps cannot be changed in the luminaire. 12 V

Remote control
for LED lamps:
Type 3333



Article	LED glass rim lamp for assembly units	
H x W x D in cm	for 35.3 cm width; 1.2 W	for 70.5 cm width; 2.7 W
Order no.	1636	1671
RRP *		

E

Carcase, substructure, metal module versions, bookshelf frame system, desk

Front versions

Price group I
White lacquer
Grey lacquer
Silk grey lacquer

Price group I
White lacquer
Grey lacquer
Silk grey lacquer

Price group II
High-gloss white lacquer
High-gloss grey lacquer
High-gloss silk grey lacquer
Natural oak
Core walnut

NEW

6 and 8 Raster single units

Single units 6R

108,1 cm high
(108,8 cm high
incl. 0.7 cm high
plinth adjusters)

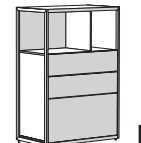
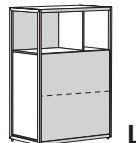
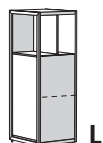

Article	Single units 6R		
H x W x D in cm	108.1 x 38.3 x 42	108.1 x 73.5 x 42	108.1 x 73.5 x 42
Order no.	16141 L / 16142 R	16121 L / 16122 R	16131 L / 16132 R
Price group I *			
Price group II *			

Single units 6R

108,1 cm high
(108,8 cm high
incl. 0.7 cm high
plinth adjusters)

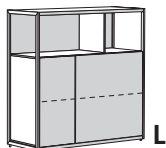

Article	Single units 6R	
H x W x D in cm	108.1 x 108.7 x 42	108.1 x 108.7 x 42
Order no.	16101 L / 16102 R	16111 L / 16112 R
Price group I *		
Price group II *		

Single units 8R

143,3 cm high
(144,0 cm high
incl. 0.7 cm high
plinth adjusters)

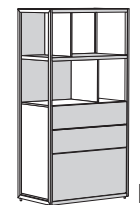
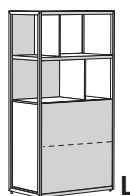
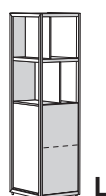

Article	Single units 8R		
H x W x D in cm	143.3 x 38.3 x 42	143.3 x 73.5 x 42	143.3 x 73.5 x 42
Order no.	18141 L / 18142 R	18121 L / 18122 R	18131 L / 18132 R
Price group I *			
Price group II *			

Single units 8R

143,3 cm high
(144,0 cm high
incl. 0.7 cm high
plinth adjusters)

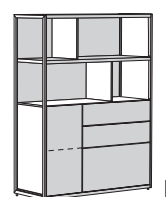
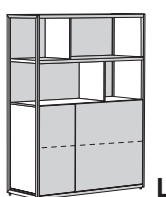

Article	Single units 8R	
H x W x D in cm	143.3 x 108.7 x 42	143.3 x 108.7 x 42
Order no.	18101 L / 18102 R	18111 L / 18112 R
Price group I *		
Price group II *		

Possible arrangements



E

Carcase, substructure, metal module versions, bookshelf frame system, desk

Accent versions

Price group I
White lacquer
Grey lacquer
Silk grey lacquer

Price group II
Teal blue lacquer
Petrol lacquer
Old rose lacquer



Bookshelf frame system

Bookshelf frames

108.1/143.3/213.7 cm high
(108.8/144.0/214.4 cm high
incl. 0.7 cm high legs)

Bookshelf frames, spacer bars and fitted shelves in carcass versions. If assembly units are fitted between bookshelf frames, a fitted shelf is essential at the bottom of the lowest assembly unit. For constructional reasons at least 2 fitted shelves must be included, for 12 Raster bookshelf frames a third shelf must be included.



Article	Outer bookshelf frame 6R	Centre bookshelf frame 6R	Outer bookshelf frame 8R
H x W x D in cm	108.1 x 1.5 x 42.1	108.1 x 1.5 x 42.1	143.3 x 1.5 x 42.1
Order no.	1961	1962	1981
Price group I *	-	-	-
Price group II *	-	-	-

Bookshelf frames, spacer bar

108.1/143.3/213.7 cm high
(108.8/144.0/214.4 cm high
incl. 0.7 cm high legs)

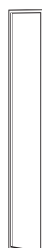

Spacer bar can be fitted as a connection between fitted shelves and/or assembly units and as the side end unit

Article	Centre bookshelf frame 8R	Outer bookshelf frame 12R	Centre bookshelf frame 12R	Spacer bar
H x W x D in cm	143.3 x 1.5 x 42.1	213.7 x 1.5 x 42.1	213.7 x 1.5 x 42.1	2.5 x 37.1 x 1.5
Order no.	1982	1911	1912	1900
Price group I *	-	-	-	-
Price group II *	-	-	-	-

Fitted shelves

Bookshelf frames, spacer bars and fitted shelves in carcass versions. If assembly units are fitted between bookshelf frames, a fitted shelf is essential at the bottom of the lowest assembly unit. For constructional reasons at least 2 fitted shelves must be included, for 12 Raster bookshelf frames a third shelf must be included.



Article	Fitted shelves		
H x W x D in cm	2.5 x 35.3 x 42.1	2.5 x 70.5 x 42.1	2.5 x 105.7 x 42.1
Order no.	1135	1170	1105
Price group I *	-	-	-
Price group II *	-	-	-

Rear walls

Rear wall with partition in all carcass and accent versions as well as in natural oak and core walnut. Please state all the versions clearly in the order!
Rear wall with partition can only be fitted in combination with assembly units and/or fitted shelves!



Article	Rear walls with partition		
H x W x D in cm	32.7 x 35.3 x 38.2	32.7 x 70.5 x 38.2	32.7 x 105.7 x 38.2
Order no.	17381 (as illustrated) / 17382 (vice versa)	17711 (as illustrated) / 17712 (vice versa)	17161 (as illustrated) / 17162 (vice versa)
Price group I *	-	-	-
Price group II *	-	-	-

Angled shelves

incl. wall bracket

Wall panel of angled shelves in all carcass and accent versions as well as in natural oak and core walnut; shelf in all carcass versions. Please state all the versions clearly in the order!

Angled shelves can be fitted in reverse order.

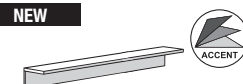
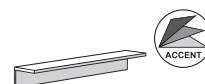
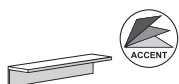

Article	Angled shelves			
H x W x D in cm	17.6 x 70.5 x 25	17.6 x 105.7 x 25	17.6 x 140.9 x 25	17.6 x 176.0 x 25
Order no.	1727	1725	1724	1723
Price group I *	-	-	-	-
Price group II *	-	-	-	-

Magnetic box versions

Snow white	Terra red
Saffron	Petrol blue
Moss green	Velvet grey

Type list

now! vision
by hülsta

● ● ● made in germany

NEW

Desk unit, metal module and magnetic box

Desk unit

Desk unit can only be fitted in the bookshelf frame system

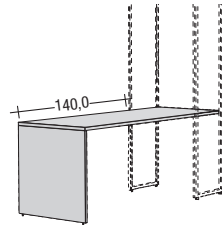

Article	Desk unit
H x W x D in cm	73.5 x 182 x 70.5
Order no.	176
Price group 1 *	

Metal module, magnetic box

Metal module can only be fitted in the bookshelf frame system

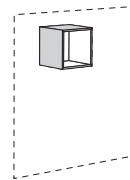
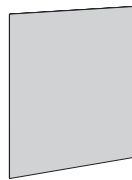

Max. load: 7 kg

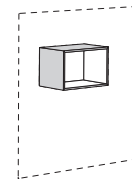

Max. load: 7 kg

Article	Metal module	Quadratic magnetic box	Square metal modules
H x W x D in cm	70.4 x 70.4 x 1.6	23.3 x 23.3 x 21.5	36.1 x 23.3 x 21.5
Order no.	1771	1221	1321
RRP *			

Magnetic hook

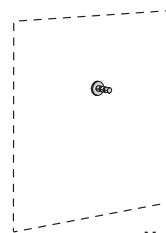

Max. load: 5 kg

Article	Magnetic hook
H x W x D in cm	Length: 9 cm
Order no.	129
RRP *	

Possible arrangements



Sketch raster for the now! vision range

Type list



● ● ● made in germany

Please superimpose unlined paper and write firmly. In order to avoid slipping, use two paper clips or fold the edge of the drawing sheet.

Checklist

- 1.) Do the **sketch** and the **order** match? Do the **dimensions** and the **sketch** match the type number? Are all **type numbers** correctly stated in the sketch? Can one see the position of **door hinges**?
- 2.) Are all **type numbers** correct? Have you perhaps confused **price** and **type numbers**?
- 3.) In combinations of **wooden, lacquer and high-gloss lacquer versions**: is it clear which units are to be delivered in which version?
- 4.) Is it clear whether the types ordered are to be employed as **wall units** or as **plinth units**? Have you remembered the **wall bracket** for wall units?
- 5.) For the **bookshelf frame system**: If assembly units are fitted between bookshelf frames, a fitted shelf is essential at the bottom of the lowest assembly unit. For constructional reasons at least 2 fitted shelves must be included, for 12 Raster bookshelf frames a third shelf must be included.
- 6.) Are all **accessories** such as lamps etc. included in the sketch?
- 7.) Is this an **additional order**? If so, when was the **original order**? If possible, include a sketch on which the existing and new units are clearly marked.

Please also remember the planning notes on the introductory pages!

Note on calculating widths for bookshelf frame combinations:

The width table states all widths up to 352.1 cm (greater widths always in steps of 35.3 cm). This width results from the shelf widths. To determine the total width, 1.5 cm must be added for each bookshelf frame!

Dims. in cm		Raster	35.3	70.5	105.7	140.9	176.1	211.3	246.5	281.7	316.9	352.1
Bookshelf frame	214.4	12										
Carcase	211.2	12										
Bookshelf frame	144.0	8										
Carcase	140.8	8										
Bookshelf frame	108.8	6										
Sideboards, carcase	70.4	4										
Lowboards	62.4	3.5										
Lowboards	44.8	2.5										
Carcase	35.2	2										
Metal substructure	12.0											
Lowboard/sideboard legs	8.6											
Legs	1.8											

Floor plan

Scale 1 : 25

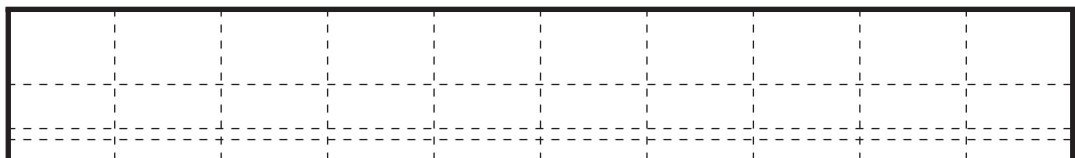
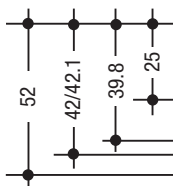

Important note!

Please do not forget to include the following details with each order. This avoids time-consuming correspondence and unnecessary delays in delivery.

Version(s)	Customer	Date	Commission
------------	----------	------	------------